

**ON FARM  
SOLUTIONS**



# TABLE OF CONTENTS

<b>1. Introduction</b>	<b>3</b>
1.1 Precision Agriculture: the future of farming	
<b>2. Weighing technology</b>	<b>6</b>
2.1 Load cells and sensors	
2.2 Weighing indicators	
2.3 Accessories	
2.4 App	
2.4.1 Dina TEL 3 App	
2.4.2 FarmCHEF	
2.5 Feedelio	
2.6 Configurations	
2.7 Smart Control	
<b>3. On-Farm analysis</b>	<b>26</b>
3.1 EvoNIR	
3.1.1 NIR for Self-propelled mixer	
3.1.2 NIR on tank	
3.2 Portable NIR analyzers	
3.2.1 AgriNIR	
3.2.2 X-NIR	
3.3 Visiomix	
3.4 Nir evolution	
<b>4. Feeding Management software</b>	<b>34</b>
4.1 DTM software	
4.2 DTM Core app	
<b>5. Smart connectivity and data exchange</b>	<b>39</b>

## 1.1 \_ Precision agriculture: the future of farming

**OUR INNOVATIVE  
APPROACH  
TO PRECISION  
AGRICULTURE  
MARKET**

Dinamica Generale is aiming at developing innovations, introducing new pioneering solutions to save costs, and reducing environmental impact.

We spend more than 10% of our revenue on R&D each year and our company is set up with a value driven, flat organization and independent teams, run projects from start to finish.

Our objective is helping farmers and growers to produce more and better food. The precision agriculture technology developed by Dinamica Generale are mainly upon a combination of weighing and connected sensors, NIR analyzers and cloud software.



### Why choose us?



#### TRACEABILITY

Dinamica Generale technology can make a significant contribution to food traceability offering innovative solutions to trace all production from field, to farm, to fork.

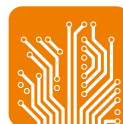

#### TECHNOLOGY

Connected sensors technologies are already widely available. Dinamica Generale is influencing work practices and new business models



#### SUSTAINABILITY

Dinamica Generale promotes more sustainable ways of farming: NIR sensor technologies and cloud software are already in use since many years with positive impacts on environment and productivity gains based on clever ways to track and use data.



#### SERVICE & SUPPORT

Precision agriculture requires the learning of new skills every day. Dinamica Generale's engineers are well trained to face:

- Complex OEM's requirements
- The wide diversity of farming practices worldwide
- Challenging applications
- Customized projects

**60%**

OF YOUR DAIRY'S  
COST OF PRODUCTION  
IS LINKED TO FEED



This is why Dinamica Generale offers you a complete management platform for a complete traceability from field to farm

# VALUE-ADDED SOLUTIONS FOR DAIRY AND BEEF FARMS THAT MAXIMISE PRODUCTION AND REVENUE

Consistent and predictable feed quality is top of mind for today's dairy and beef farmers. The project we called myfeed360 is aimed at providing farmers with the most advanced technology for monitoring, measuring and ensuring the quality of feed within each phase of animal nutrition process. Here is what we manage:

1. Input feed ration into the DTM Feed Management Software and track feed costs
2. Apply real time adjustment of each loaded ingredient based on dry matter and nutrients
3. Control TMR homogeneity and fiber lengths during mixing process in the TMR mixer
4. Measure the real quantity of feed distributed to each pen
5. Track milk production based on real dry matter intake
6. Control farm performance in real time from any location
7. Share feeding information online with nutritionists to improve the process efficiency

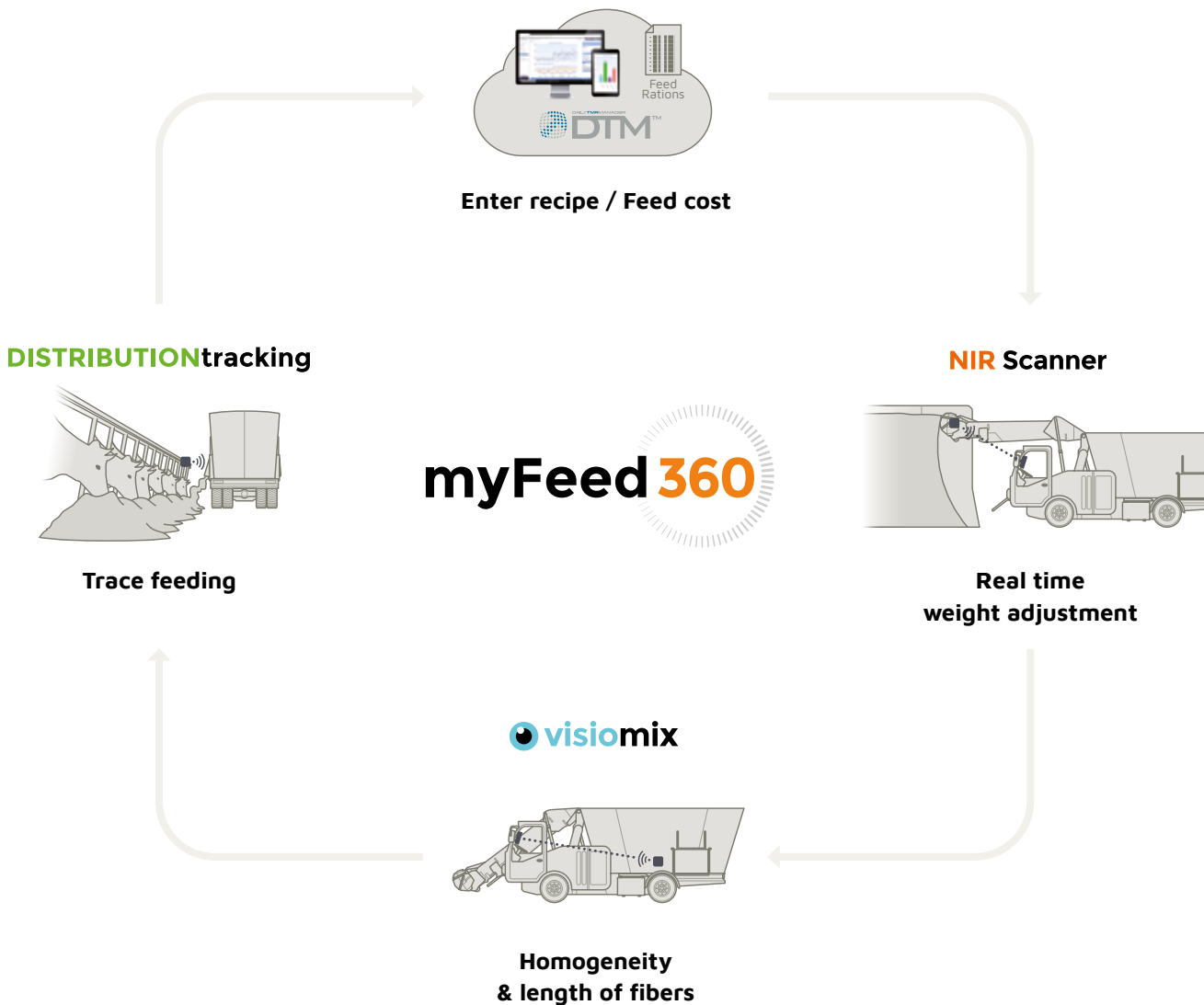

## 2. WEIGHING TECHNOLOGY



### 2.1 \_ Load cells and sensors

Choose from multiple configurations and sizes, but never compromise on **precision** and **reliability**, which are standard in each load cell manufactured by Dinamica Generale.

We have been producing load cells since the nineties to meet our customer requirements. Even though we have an extensive product offering, if you cannot find just what you are looking for, we will work with you to develop a new product to suit your needs.

Dinamica Generale offers a **comprehensive range of weighing sensors** for agricultural applications such as grain carts, forage wagons, trailers and manure-mineral spreaders. For all machines, we supply sensors, junction boxes, cables. If necessary, we also offer systems that are tailored to special applications.

#### Common load cells specs

- Full traceability of each sensor
- Factory standard pre-calibration and testing procedures
- High accuracy
- Wide range available
- TPE cables: maximum protection against moisture, flame and temperature (operating temperature -50° C ~ 90° C)
- Sealed strain gauges: sealing agent and industrial grade potting compound protect against harsh use in agricultural field
- IP68 Protection rate
- Custom mechanical design available on request

#### Connectors and junction boxes

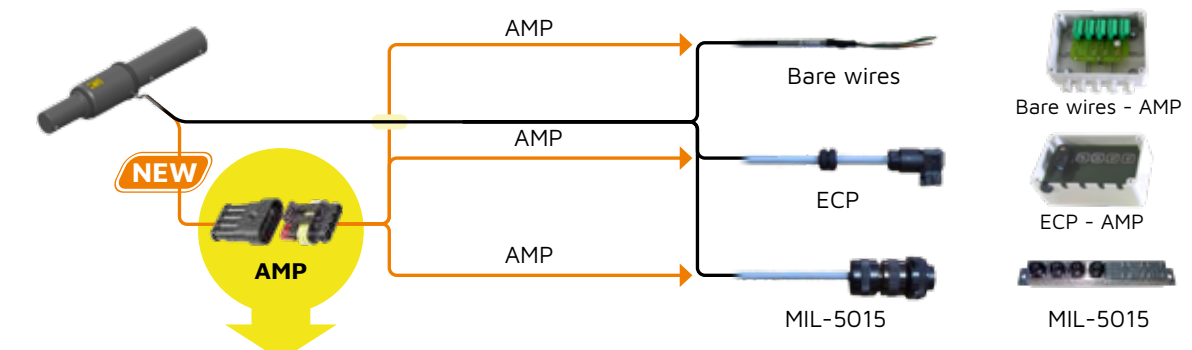

#### Easy installation:

- Load cells with AMP connector can be easily installed thanks to minimum cable length (only 10 cm - 4")
- The risk of accidentally cutting the cable during installation is minimized

#### Cost saving:

- Quick cable replacement reduces downtime of the machine to virtually zero
- In case of cable break down during field operations, only the cable is replaced instead of the load cell

#### Standard cable length m (ft):

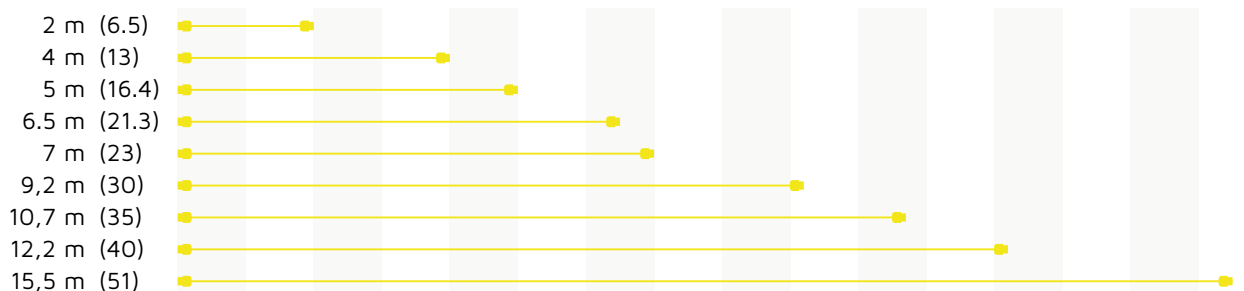



**Applications:**

Forage Wagon, Feed Mixer, Grain Cart, Trailer, Baler, Bale Wrapper, Seed Tender, Manure and Mineral Spreaders, Compactors and all farm machinery in motion.

**MOBILE**

Robust heavy-duty Mobile load cell manufactured from treated alloy steel for on-board weighing applications.

**Features**

- High-quality alloy steel: Dinamica Generale special thermal treatment makes it stable for years
- High resistant coating (480h salt spray testing)
- Aluminum protection: strain gauge protected against impact and moisture
- Temperature compensation as option

**Dimensions and capacity**

MOBILE	diameter mm (in)		capacity Kg (lb)	
	MIN	MAX	MIN	MAX
	25 (0.98)	95 (3.74)	315 (695)	15.000 (33,069)



**Applications:**

Dump bodies (Tipper Trucks), Tankers, Forage Wagon, Grain Cart, Trailer, Manure Spreader, Refuse collection trucks.

**FLAT**

Flat load cells designed for on board weighing applications. Typically installed in the underbody between tank and chassis or on single point suspension.

**Features**

- Designed for on-board vehicle weighing
- Easy to install as a retrofit for aftermarket applications
- Available with high-resistant coating (480h salt spray testing) or nickel plated coating
- Temperature compensation as option
- Custom mechanical design available on request

**Dimensions and capacity**

FLAT	length mm (in)		capacity Kg (lb)	
	MIN	MAX	MIN	MAX
	240 (6.096)	450 (17.72)	5.000 (11,023)	20.000 (44,092)

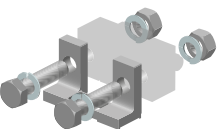

**Applications:**

Trailer, Manure Spreader, On-board Truck Weighing in general

**STRAIN SENSOR**

Strain sensors measure deformation and stress of structures. They are applied to weigh and control overloads.

**Features**

- Measuring of tension/compression strain of the body where it is fastened
- High sensitivity to small stress
- Easy assembly and disassembly (no drilling nor machining is required on structures)
- Designed for various applications (axle weighing, overload control, structures stress/strain monitoring)

**Dimensions and capacity**

STRAIN SENSOR	Measurement range
	±500 µm/m





**Applications:**

Feed Mixer, Forage Wagon, Trailer, Baler, Hay Bale Wrapper, Seed tender, Fertilizer and Mineral Spreader, Compactor

**DRAW BAR**

Robust heavy duty load cell manufactured from alloy steel for on-board weighing.

**Features**

- Specifically designed for flange towing eyes, it can be applied to factory-mounted or retrofitted equipment
- Typically installed on forage wagons, spreaders, grain carts and other on-board trailed applications

**Dimensions and capacity**

DRAW BAR	capacity Kg (lb)	
	MIN	MAX
	4.000 (8,818)	10.000 (22,045)



**Applications:**

Feed Mixers, Forage Wagon, Grain Cart, Trailer, Manure Spreaders, in-motion vehicle in general

**SPINDLE**

Spindle load cells are installed on axles. Typically installed on 3 and 4 point scale systems.

**Features**

- High-quality alloy steel: dinamica generale special thermal treatment makes it stable for years
- High resistant coating (480h salt spray testing)
- Temperature compensation as option
- Custom mechanical design available on request

**Dimensions and capacity**

SPINDLE		from	to
Diameter	mm (in)	63,5 (2.5)	114 (4.5)
Capacity	Kg (lb)	5.000 (11,023)	13.000 (28,660)



**Applications:**

Forage Wagon, Feed Mixer, Grain Cart, Trailer, Manure Spreader.

**COMPRESSION**

With rated loads ranging from 13t to 22t Dinamica Generale compression load cells are applicable for a variety of agricultural and on-board applications

**Features**

- Designed for high capacity stationary/mobile applications (grain carts, weighbridges, silos)
- Aluminum protection: strain gauge protected against impact
- Temperature compensation as option

**Dimensions and capacity**

COMPRESSION	dimensions mm (in)		capacity Kg (lb)	
	LENGTH	DIAMETER	MIN	MAX
	108 (4.25)	73 (2.87)	13.608 (30,000)	22.680 (50,000)



**Applications:**

Tipper Trucks,  
 Forage Wagon,  
 Grain Cart, Manure  
 Spreader.

**PIN**

Hinge pin load cells for real time monitoring of load forces. Typically installed at the rear hinge pivots of tipper trucks

**Features**

- Ideal as a retrofit, pin load cells can be easily integrated in aftermarket equipment without taking up space (such as dump truck pivot hinges)
- Suitable for a variety of applications (pulleys, shackles etc.)
- Manufactured from 17-4 PH Stainless Steel that provides an outstanding combination of high strength, good corrosion resistance and good mechanical properties

**Dimensions and capacity**

PIN	dimensions mm (in)		capacity Kg (lb)	
	MIN	MAX	MIN	MAX
	35 (1.38)	60 (2.36)	3.000 (6,614)	10.000 (22,046)

**Connection scheme**

Type: Mobile load cells  
 Range of capacity: 1-10 t



Type: Flat load cells  
 Range of capacity: 10-20 t



Type: Compression load cells  
 Range of capacity: 15-23 t

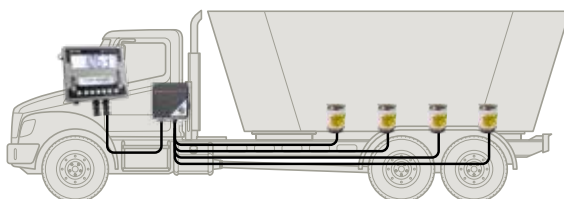
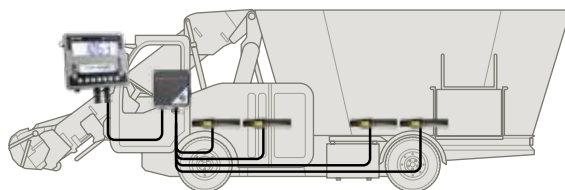
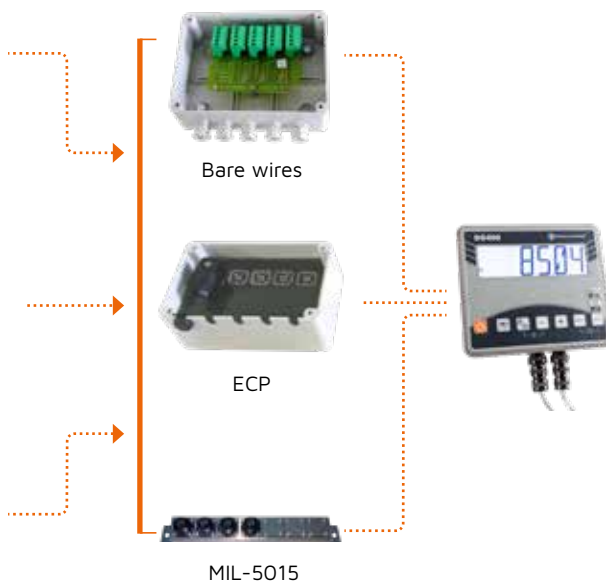

## 2.2 \_ Weight indicators

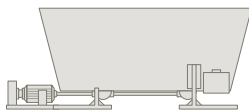
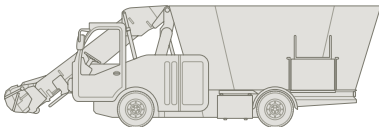
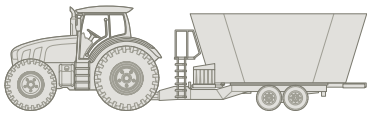

### The right indicator for any requirement

The wide range of weight indicators offers integrated functionality and different options based on performance required. What can you benefit ?

- Scalable, flexible range designed for any feeding applications requirement (trailed or self-propelled feed mixer, stationary feed mixer, automatic feeding system etc...)
- Balanced price-performance ratio
- Minimization of downtimes thanks to integrated monitoring and diagnostics
- Multi-language intuitive user interface (all EU languages, Chinese, Russian, etc...)
- IP 68 protection for all weight indicators



Model	<b>DG400</b>
Description	Digital weight indicator
Features	<ul style="list-style-type: none"> <li>• Overload control for improved operator security</li> <li>• Working mode: total/partial and net/gross weight</li> <li>• WiNETTM port for plug &amp; play connection of ALL accessories</li> <li>• All models of load cells can be connected</li> <li>• Modbus - CAN J1939 protocols on request</li> </ul>



Model	<b>DG500</b>
Description	Programmable weight indicator for small and medium farms
Features	<ul style="list-style-type: none"> <li>• 24 Recipes, 18 components each (from a list of 48 components)</li> <li>• 24 Distribution programs with 18 distribution points for each program (from a list of 48 distribution points)</li> <li>• Service function with overload recorder and working time counter</li> <li>• Compatible with the DTM Cloud Software Advanced Version</li> <li>• Component consumption counter</li> <li>• Download executions report in excel</li> <li>• FarmCHEF - DinaTEL 3 APP compatibility</li> </ul>



Model	<b>DG600</b>
Description	Programmable weight indicator for medium and large farms
Features	<ul style="list-style-type: none"> <li>• 99 Recipes, 24 Components each (from a list of 99 components)</li> <li>• 48 Distribution programs with 48 distribution points for each program (from a list of 64 distribution points)</li> <li>• Compatible with the DTM Cloud Software Advanced Version</li> <li>• Wireless data exchange between indicator and DTM software via the 4G modem</li> <li>• Multi language interface including ideograms (chinese, japanese, etc)</li> <li>• FarmCHEF - DinaTEL3 APP compatibility</li> </ul>



Model	<b>DG8000</b>
Description	Programmable weight indicator for large farms and contractors
Features	<ul style="list-style-type: none"> <li>• Programs can be modified directly from the scale (cows number, components kg etc.)</li> <li>• Wireless data exchange between indicator and DTM software via the 4G or WiFi modem</li> <li>• Compatible with DTM Cloud Software Professional version</li> <li>• Refused management</li> <li>• Working time in each farm for an efficient bookkeeping</li> </ul>



Model	<b>DG8000-IC</b>
Description	Programmable weight indicator for structured and demanding farms
Features	<ul style="list-style-type: none"> <li>• Recipe formulation based on daily dry matter intake for each pen</li> <li>• Premix management</li> <li>• Specifically designed for integrating NIR Analyzers</li> <li>• Monitoring operators' labor effectiveness</li> <li>• Suitable for automatic feeding plants</li> <li>• Compatible with the DTM Cloud Software IC version</li> <li>• Multi ration management</li> <li>• Modbus protocol built in</li> </ul>

### 2.3 \_ Accessories

We offer a variety of accessories to meet your needs. From remote displays to remote control and ECU for feeding automation plant.

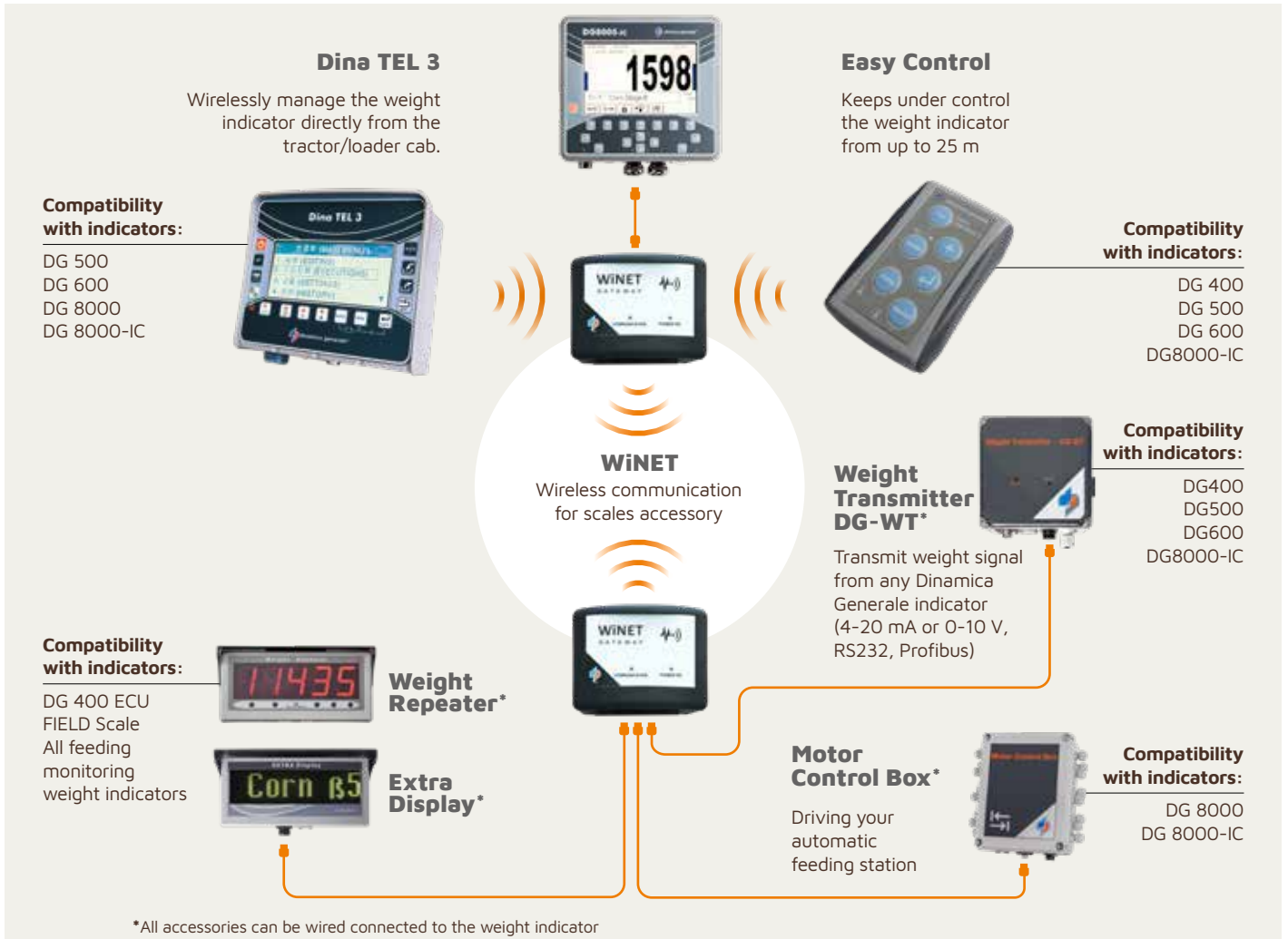

#### Model **Weight Repeater**

- Description
- High efficiency LED display to be visible in any lighting conditions.
  - Clear and comfortable viewing of weight information from any position.
  - Shorter set-up time and easy connection to the weight indicator.



#### Model **Extra Display**

- Description
- LED Display to control weight and components name even from long distance (over 30 m - 100 feet).
  - High performance display even in direct sunlight.



Model	<b>EASY CONTROL 2 WiNET™</b>
Description	Remote control to manage the indicator from up to 25 m (82 feet). With the WiNET Modem Interface, the remote control can be used with all Dinamica Generale wireless accessories without any interference: all devices communicate within the same network.
Model	<b>Dina TEL 3</b>
Description	Dina TEL 3 is a wireless remote control with a large display that shows information regarding all feed operations. Dina TEL 3 is equipped with an intuitive keyboard to manage the weight indicator directly from the tractor/loader cab, make the tare, enter in loading program etc.
Model	<b>Dina TEL 3 APP</b>
Description	Dina TEL 3 App is the ultimate technology developed by Dinamica Generale that brings the control of the weight indicator to your smartphone or tablet. By simply installing the DG Wi-Fi Gateway, you can turn your smartphone into a weight indicator and make loading process more efficient. Experience a new way of work, download the DinaTEL3 App on Google Play and App Store and start using your mobile during daily operations to enjoy its ease of use.

## Distribution Tracking

With the aim of improving the efficiency and control of animal feed rations, Dinamica Generale is promoting an electronic device which marks out the material to be discharged in front of each pen through tag system technology that tracks the feed distributed. (Distribution tracking is available only for DG8000-IC weight indicator)

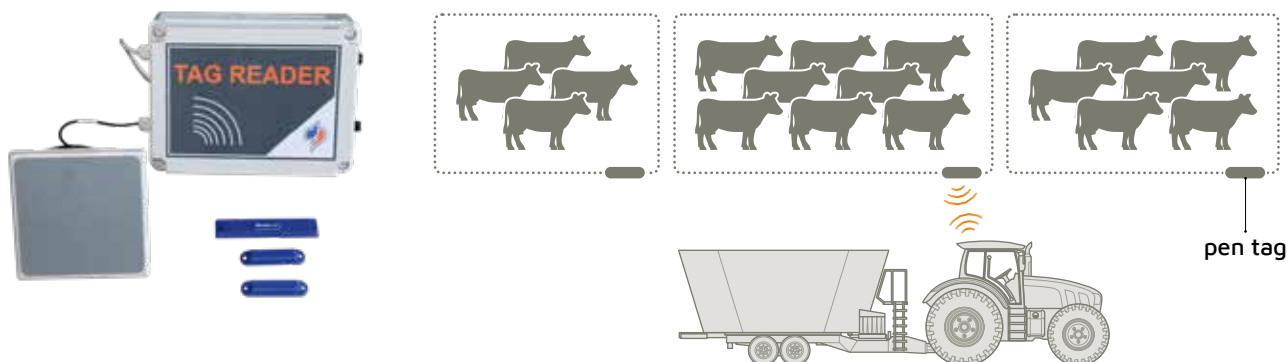

### CUSTOMERS' BENEFITS

- Track delivered TMR for each pen and keep distribution under control
- Operator accuracy monitoring for continuous process improvement
- Delivering the right quantity of TMR means decreasing feed refusal thus reducing feeding costs.

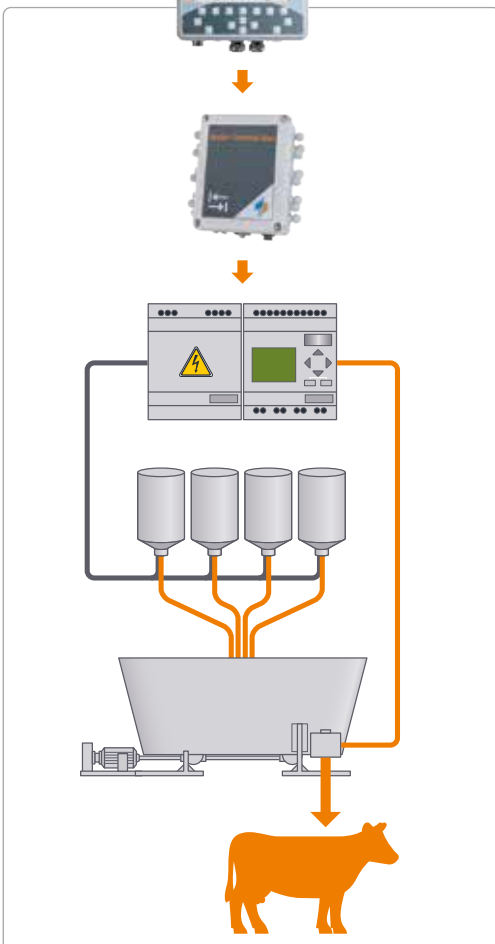

## Motor Control box

The Motor Control Box is the one-stop solution to control animal feed automation plants.

With the Motor Control Box, driving functions like open the doors, start belts and control material discharge from silos to name but a few, become easier and quicker.

### 1) AUTOMATIC LOADING PROCESS

The system is designed to control and automatically manage ingredients stocked in silos to get the best possible TMR quality.

### 2) AUTOMATIC DISTRIBUTION PROCESS

The Motor Control Box sets the control of the TMR distribution from the feed mixer right in front of cows. Thanks to the DTM Feeding Management Software, programs can be set directly from the office.

Indicators' Compatibility	DG8000 - DG8000-IC
Benefits	<ul style="list-style-type: none"> <li>• Efficient automation control during loading and distribution of feeding material within stationary mixing systems</li> <li>• Flexible. The system can be set by the customer on the basis of his need</li> <li>• Reliable. Automatic control of the entire process without the presence of operators</li> <li>• Profitable. Greater accuracy, less waste of material</li> </ul>



Model	<b>Weight Transmitter DG-WT</b>
Indicators' Compatibility	DG400 - DG500 - DG600 - DG8000 - DG8000-IC
Description	The Weight Transmitter DG-WT is a digital-analog weight transmitter specifically designed for Dinamica Generale weight indicators. Particularly suited for biogas applications, DG-WT can be used in different applications from simple weighing to mixing and filling stations, in conjunction with PLCs, computers or other supervisory systems.
Features	<ul style="list-style-type: none"> <li>• Transmit weight signal from each Dinamica Generale indicator (4-20 mA or 0-10 V, RS232)</li> <li>• 3 digital outputs (PWR1,PWR2,PWR3) - 4 analogical outputs</li> <li>• Pro bus module as option</li> </ul>
Benefits	<ul style="list-style-type: none"> <li>• Easy to calibrate</li> <li>• High precision</li> <li>• Durable compact design</li> </ul>



Discover all accessories compatibility



## 2.4 \_ App solutions



### Unleash the power with DG Wi-Fi Gateway

Dinamica Generale has developed innovative app solutions to help farmers manage the feeding process directly from mobile device.

Discover the new feeding experience, keeping under control all the feeding process directly with your smartphone or tablet.

DG Wi-Fi gateway allows to link Dinamica Generale's weight indicators with FarmChef or DinaTEL 3 APP.

Download apps on your mobile device and connect your Dinamica Generale's weight indicator with DG WiFi Gateway to start feeding.

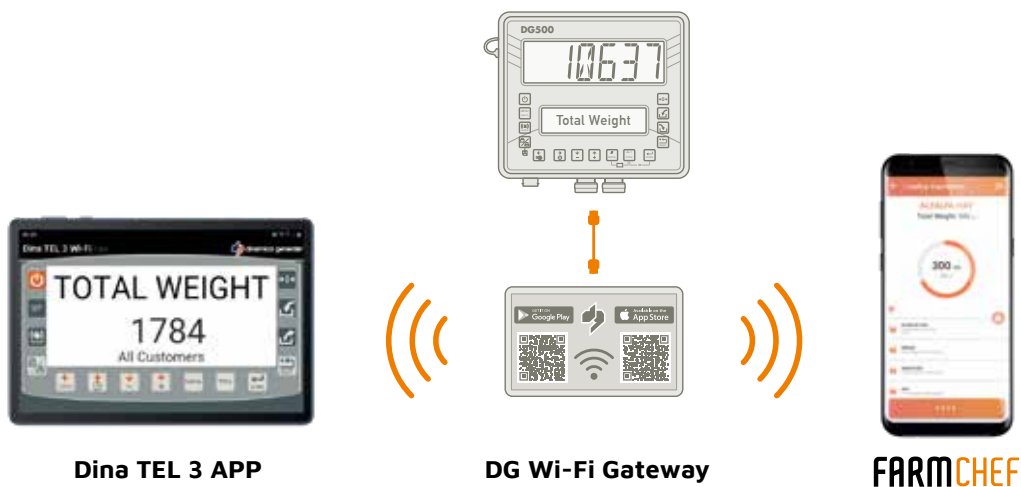

## 2.4.1 \_ DINA TEL 3 APP

DinaTEL 3 APP is a mobile APP that brings the control of the weight indicator to your mobile device.

Farmers can make tare, enter in feeding programs, etc. directly from the loader. DinaTEL 3 APP is available for Android and iOS and compatible with DG500, DG600 and DG8000-IC indicators.



### Dina TEL 3 App

- Turns your smartphone into a remote control to make loading process more efficient, precise and faster.
- Easily view and control weight functions from your smartphone
- Works with DG500, DG600 and DG8000 IC.



## 2.4.2 \_ FarmCHEF



# FARMCHEF

**FARMCHEF** is a cloud based precision feed management system. The smart and simple design lets you easily build and manage rations, pens, and **feed groups directly with your smartphone/tablet.**

Set up rations on-the-go, control the performances on the app and connect to the DTM cloud software to compare and exchange data. The app is linked to the weighing system in the mixer wagon in real-time.



*All the DG500 and DG600 indicators on the market can be upgraded to work with DG WiFi Gateway*



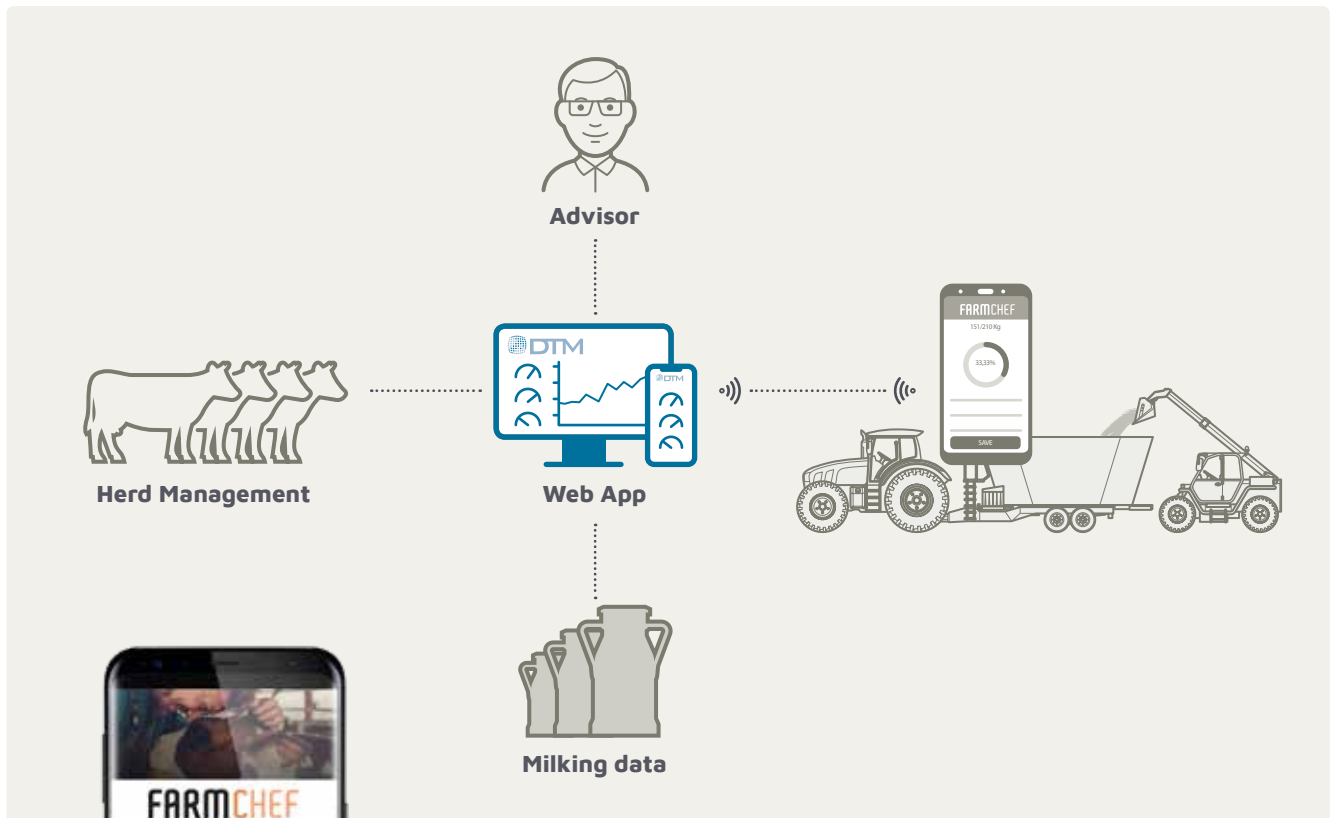
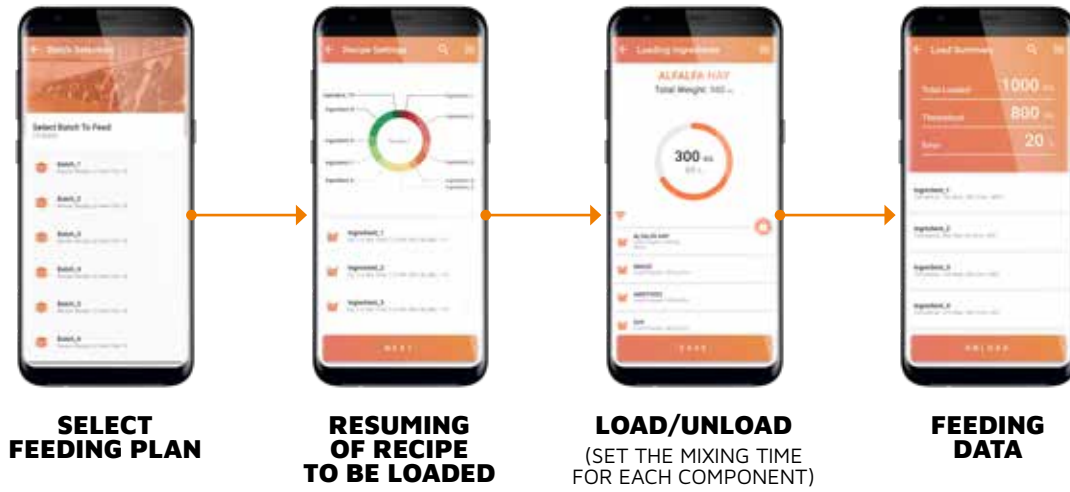

- Faster and interactive feeding experience during loading and distribution
- Run feeding reports directly from the app and share via mail, whatsapp, etc.
- Plug & play suitable for each brand of feed mixer
- Connect to DTM FarmCHEF software in Cloud to monitor feed costs, inventory and all important KPIs of your farm





**2.5 \_ Feedelio**

Feedelio is the precision feeding system designed for farmers to control all stages of animal nutrition process from recipe preparation, data transmission up to distribution of feed rations. The Feedelio System manages all data collected daily within the feed process and turns them into useful information to increase efficiency and farm performance.



Feedelio consists of DTM – Daily TMR Manager, the comprehensive feed management software in the Cloud designed to optimize daily feed process, a programmable weight indicator, a 4G modem for data exchange and the DTM app to monitor the key performance of your farm. The system can be equipped with the NIR scanner (for both self-propelled and trailed feed mixer) which enables to enhance even further the quality control of animal nutrition.



Solutions	System configuration	Value for customer
<p><b>FEDELIO 600 Advanced CLOUD</b></p> <ul style="list-style-type: none"> <li>• DG600 indicator</li> <li>• DTM Daily TMR Manager Software (Advanced Version)</li> <li>• 4G modem for reliable data transfer</li> <li>• DTM App</li> </ul>		<ul style="list-style-type: none"> <li>• Full automatic control of working time and costs from recipe preparation to material feedout of each group of animals</li> <li>• Control of the labour times</li> <li>• Control and management of the inventory</li> <li>• Control of dry matter for each ingredient</li> </ul>
<p><b>FEDELIO 8000 Professional CLOUD</b></p> <ul style="list-style-type: none"> <li>• DG8000 indicator</li> <li>• DTM Daily TMR Manager Software (Professional Version)</li> <li>• 4G modem for reliable data transfer</li> <li>• DTM App</li> </ul>		<ul style="list-style-type: none"> <li>• Management of refused</li> <li>• Specific features for contractors applications</li> <li>• Operator's control through specific login</li> <li>• Fully integrated with NIR analysis systems</li> </ul>
<p><b>FEDELIO IC CLOUD</b></p> <ul style="list-style-type: none"> <li>• DG8000-IC indicator</li> <li>• DTM Daily TMR Manager Software (IC Version)</li> <li>• 4G modem</li> <li>• DTM App</li> </ul>		<ul style="list-style-type: none"> <li>• Management of refusals</li> <li>• Fully integrated with NIR analysis systems</li> <li>• Premix management and traceability</li> <li>• Optimum feeding control for maximum beef and dairy production</li> </ul>

## 2.6 \_ Available configurations

## Solutions

## System configuration

## Configuration 1

- Weight Indicator: DG500
- Remote Display: EXTRA Display + WiNET Modem
- Remote Control: Dina TEL 3

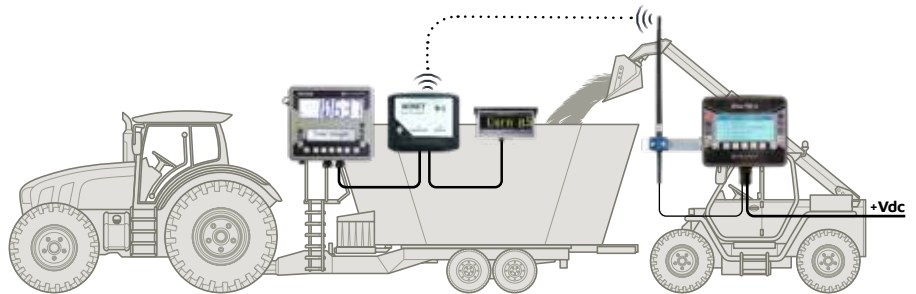

## Configuration 2

- Weight Indicator: DG600
- APP: FarmChef / DG Wi-Fi Gateway

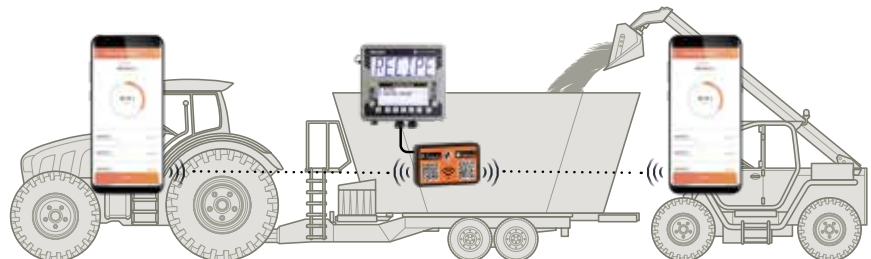

## Configuration 3

- Weight Indicator: DG8000-IC
- Data Exchange: 4G Modem
- DTM Core App
- Feeding Management: DTM IC Cloud Software
- Remote control: Dina TEL 3 App



**Solutions**

**System configuration**

**Configuration 4**

- Weight Indicator: DG8000-IC
- Remote Display: EXTRA Display + WiNET Modem
- Remote Control: Dina TEL 3
- Feeding Management: DTM IC Cloud Software
- DTM Core App
- EvoNIR Analyzer
- Data exchange Modem 4G



**Configuration 5**

- Weight Indicator: DG8000-IC
- Data Exchange: 4G Modem
- Feeding Management: DTM IC Cloud Software
- DTM Core App
- Remote display: Extra Display
- EvoNIR Analyzer

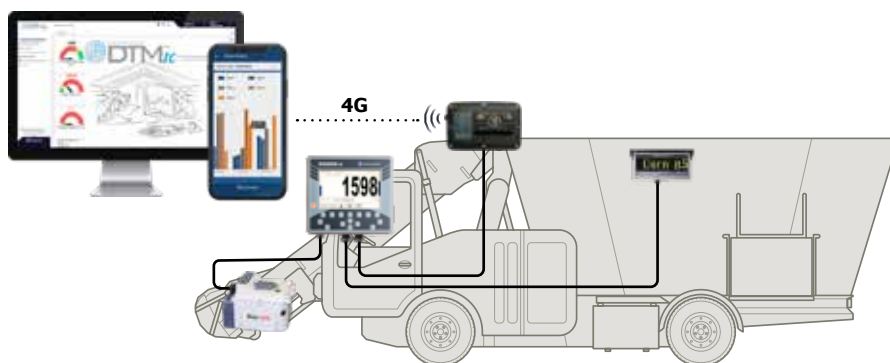

**Configuration 6**

- Weight Indicator: DG8000-IC
- Feeding Management: DTM IC Cloud Software
- DTM Core App
- Motor control box
- Data exchange Modem 4G

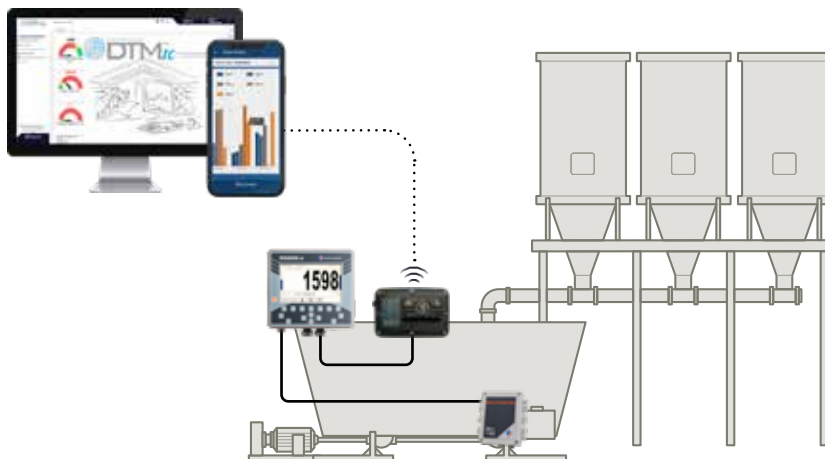



## 2.7 \_ SMART Control



## SMART Control

### Wireless Scale Indicator

#### Completely Portable Scale - in the tractor - in the field - on the farm

More than a Portable Scale. Smart Control is the one- stop portable wireless solution for hydraulic and weighing functions. The device can be customized as weighing device only, hydraulic or integrating weighing and hydraulic functions together.

The hydraulic functions are highly customizable managing up to 24 solenoid valves with internal sound alarm and color display for high visibility. Open/Close discharge doors, activation of belt conveyors are just a few functions that Smart Control is capable of controlling.

Furthermore, all functions controlled by the Smart Control can be easily programmed thanks to the Smart i-Con software, a specific cloud tool designed for configuring your device to suit your needs.



### CUSTOMERS' BENEFITS

- Save time during loading and unloading by controlling the hydraulic functions
- Highly customizable solution in terms of functions and graphic design to fit every customer's needs.
- All scale weighing and hydraulic functionalities in the palm of your hand



Dinamica Generale has developed NIR technology systems since the year 2000. Thousands of installations worldwide, vast on-site, real time analysis experience and internal calibration curves generation capabilities are the foundation of our success.

Farm managers, nutritionists, biogas plant owners, growers and contractors, to name a few, are using Dinamica Generale NIR analyzers worldwide to make intelligent decisions and take immediate, effective actions to optimize profits.

### 3. ON-FARM ANALYSIS

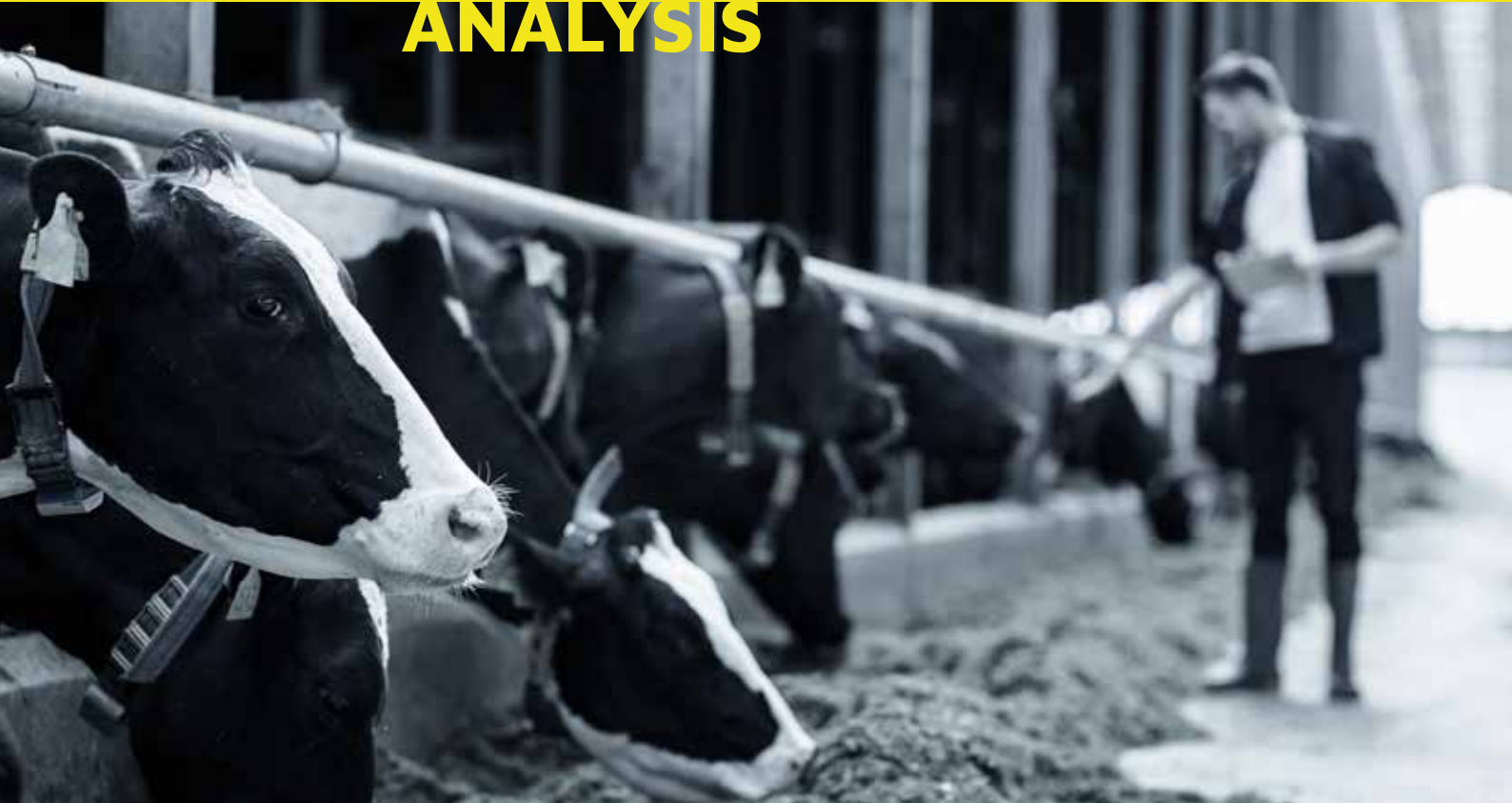

## 3.1 \_ NIR Technology: EvoNIR 4.0

**EvoNIR 4.0. Near perfection.**

Whether your objective is growing, field fertilizing, biogas generation, or dairy production, precision is the keyword for successful farming. With EvoNIR sensor technology, farmers, growers and contractors can achieve a new level of accuracy and efficiency with real time data directly in the field.

Mounted on agricultural machinery and feeding plants, EvoNIR is capable of measuring dry matter, protein, starch, fiber, neutral detergent fiber, acid detergent fiber, ash, sugar and many other nutrients in real time with outstanding accuracy.

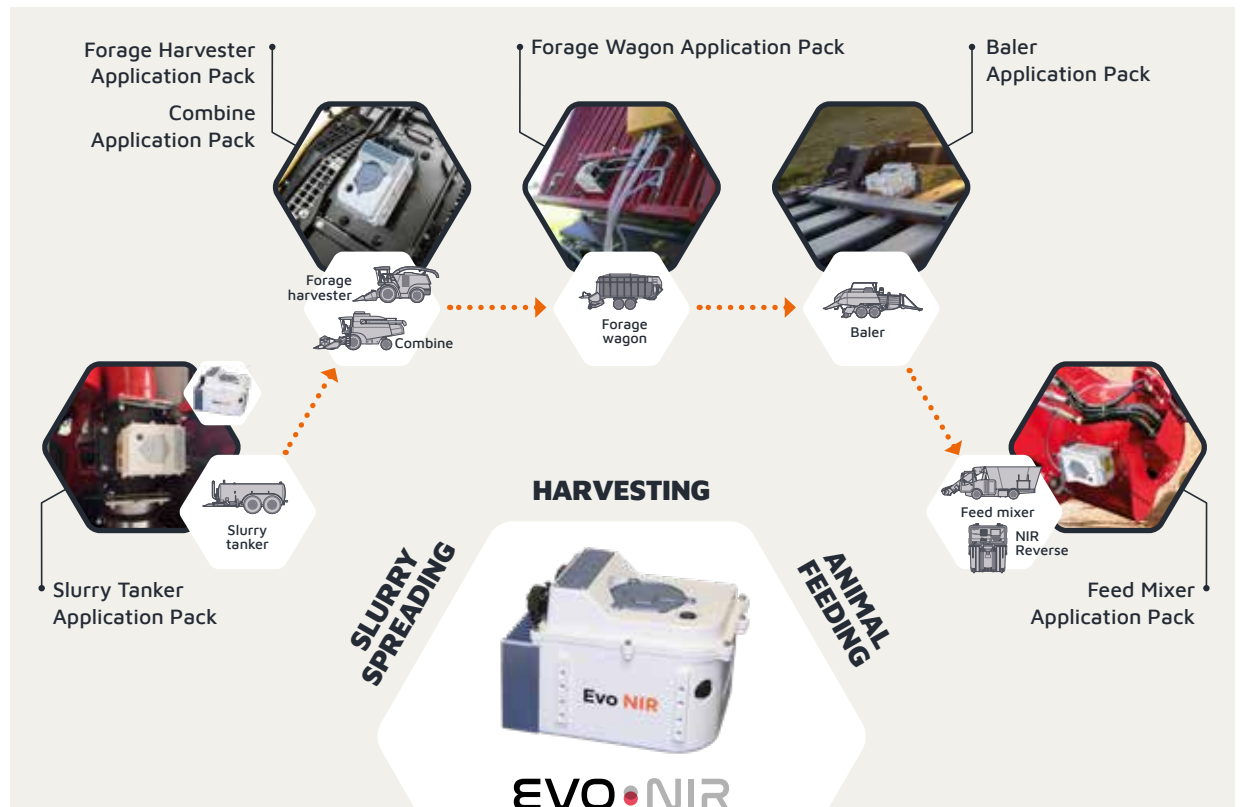
**CUSTOMERS' BENEFITS**

- **Crop growers:**

Detect plant disease in advance for more effective use of agrochemicals and a more sustainable method of crop management. Measure plant quality prior to harvest, during and after harvest.

- **Contractors:**

Provide additional services to customers by offering valuable crop analysis and yield maps. Make adjustments to chopper if excess ash is detected while harvesting.

- **Biogas plant owners:**

Biogas plants have DM based contracts with farmers and contractors that deliver either freshly chopped crops or silage. Perform constant monitoring of nutrients of what is being delivered ensures better plant performance.

Monitoring the level of nutrients in silage is a key factor to ensure an homogenous production of Biogas.

- **Dairy and beef farmers:**

Automatic adjustment of feed ration for dairy cows and beef cattle based on nutritional value to improve quality, production and profits.

## ON-FARM ANALYSIS

### 3.1.1 \_ NIR for Self-propelled mixer



Using patented technology, EvoNIR measures in real time dry matter and key nutrients (protein, ADF, NDF, ash, crude fat, starch, etc). The system recalculates in **real time** the weight to be loaded for each component to ensure a consistent ration. All data are stored in the DTM Cloud software.

By measuring Dry Matter and other nutrient content in real time, farmers can:

- Increase milk production thanks to a correct management of feeding process
- Manage of forages variability (weather conditions)
- Manage of the refused level
- Improve of cows health-behaviour

The system gives farmers complete control over their ration components.

With NIR technology, farmers can automatically adjust every TMR batch for Dry Matter in real time and easily modify nutrient variations to match nutritionist recommendations.

The EvoNIR combined with Dinamica Generale precision feeding systems gives farmers the total package of tools they need to feed a **precise ration** on every feedout. This helps farmers become more proactive, more consistent and better managers.



## ON-FARM ANALYSIS

### 3.1.2 \_ NIR on tank



EvoNIR installed on the tub of the feed mixer can continuously monitor the quality of the mixture. Real time analysis with adjustment guarantees an **homogenous** and **constant** TMR in line with consultants formulation.

- Homogeneity index
- Define the correct time to stop mixing
- TMR Analysis
- H<sub>2</sub>O quantity adjustment

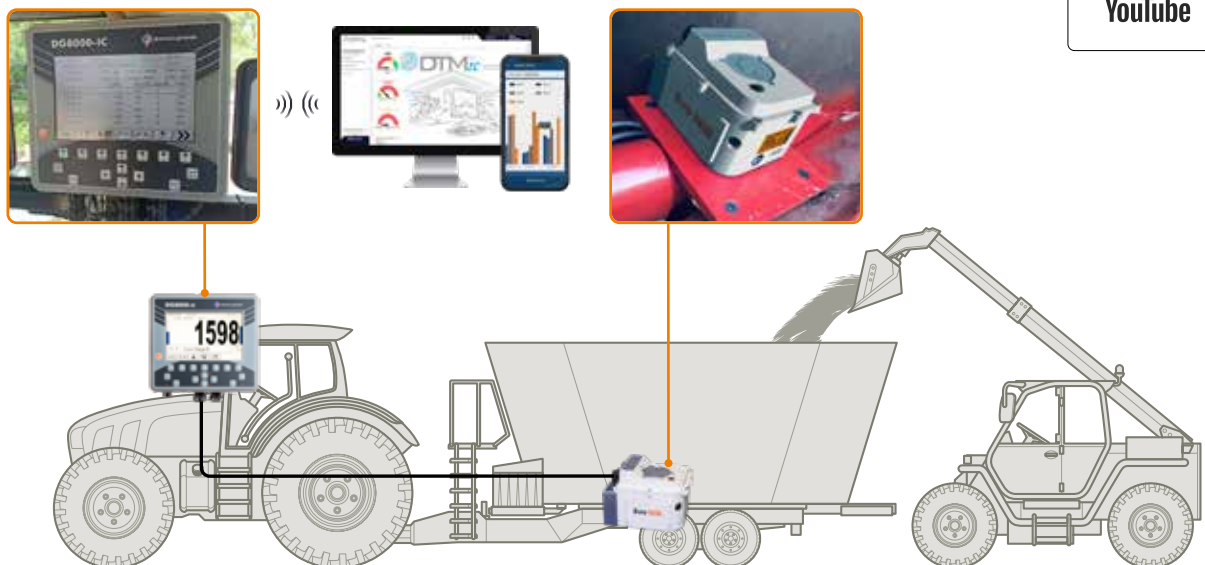

## 3.2.1 \_ Portable NIR analyzer for forages and grains



## AgriNIR

### Your own lab on-the-go



AgriNIR is the nutritionist's toolbox for feed sampling, testing and ration adjustment in real time.

Dairy farmers need quick and accurate recommendations. The more time it takes for a response, the more impact it can have on milk production and the bottom line.

AgriNIR is tried and tested **portable analyzer** for forages and grains that measure the percentage of moisture (dry matter), crude protein. Starch, ADF, NDF and ash in seconds.

- **AgriNIR:** 7 preloaded ingredients as standard (Corn Silage, Hay, High Moisture Corn, Alfalfa Hay, Grass Silage, TMR, Soybean Flour)
- **AgriNIR Slurry:** 4 preloaded ingredients as standard (pig slurry, cow slurry, mixed slurry and digestate). Connects to computer via USB port and Wi-Fi with GoCloud Gateway to share results and perform statistics. Print out reports right after the analysis thanks to the built-in printer.

## Main target customers

 <p><b>Precision Feeding</b></p>	<p><b>Nutritionist</b> AgriNIR is the nutritionist's toolbox for feed sampling, testing and ration adjustment in real time. Dairy farmers need quick and accurate recommendations. The more time it takes for a response, the more impact it can have on milk production and the bottom line.</p>
 <p><b>Precision agriculture</b></p>	<p><b>Grower/Contractor</b> <u>AgriNIR:</u> determining the right time to harvest is extremely important and sometimes difficult. Thanks to AgriNIR the right timing of cutting can be easily determined analyzing dry matter contents of samples from windrows or different crops on-the-go <u>AgriNIR Slurry:</u> speeding up the process of slurry analysis in the field before fertilizing cuts costs, time and increase productivity.</p>
 <p><b>Biogas plants</b></p>	<p><b>Plant owner</b> Biogas plant managers can perform a full NIR analysis to check the DM and all other parameters of loads of grass and silage delivered by contractors. The analysis can be done in the silage pit too and in under any circumstances since the analyzer can be powered by the tractors/car's lighter.</p>

## AgriNIR CUSTOMERS' BENEFITS

- **Reliable.** The highest possible accuracy on-site.
- **Robust.** Sturdy case, full-portability, minimum maintenance
- **Versatile.** Determine the right time to harvest. Check quality of feed purchased. Control feed inventory.
- **Profitable.** Value for money
- **Quick and easy to use.** NIR analysis in seconds!
- **Transfer data wireless to NIR Trace Cloud software**

## 3.2.2 \_ X-NIR



## X-NIR

### Daily handheld analysis for everyone

X-NIR Portable NIR Analyzer for anywhere, anytime feed analysis. By taking NIR technology into the production facility in the form of a portable, handheld unit, feed manufacturers and farmers can obtain **real-time results** while reducing costs from third-party testing.

X-NIR takes lab-proven technology off the bench and makes it usable by non-scientists. Results that are available within minutes on-site enabling actionable decisions that increase profitability.

- 5 ingredients as standard on each analyzer to pick from more than 60 ingredients available
- Connects to computer via USB port and Wi-Fi with GoCloud Gateway to share results and perform statistics
- 4"3 Touch screen lets you access all functions with a simple fingertip
- No need of internet connection to get results
- Transfer data wireless to NIR Trace Cloud software



## Main target customers



### Plant owner

Measuring acceptance of raw materials before processing reduces down-time and production delays.



### Dairy farmers

For small to medium-sized dairy farms as portable solution for real-time daily feed analysis. Feed livestock the most effective ration as prescribed from the nutritionist.



## NIR TRACE

Cloud based data management software to check and download advanced reports and trends.

- Manage customers, perfect tool for advisors
- Use reports and graphs for quick and smart decisions

## 3.3 \_ Visiomix

VISIOMIX is an innovative system based on **computer vision technology** that is capable of measuring the **homogeneity** and **length of fibers** in the feed mixer during TMR mixing.

**HOW IT WORKS**

The VISIOMIX system is equipped with a digital camera that automatically analyzes and compares the acquired frames.

The farmer defines the right degree of TMR mixing quality on a specific app, when the VISIOMIX recognizes that the TMR quality target is achieved, the farmer receives a notification on his smartphone. In addition, acoustic and visual signals on the feed mixer advise the operator.



- The VISIOMIX system can be mounted on every feed mixer on the market.
- Controlling homogeneity and length of fibers is of paramount importance to improve rumination, sorting activity, production yield and animal health.
- VISIOMIX in association with Precision Feeding systems provided by Dinamica Generale offers the opportunity to extend the control of feeding up to the TMR with positive effects on productivity of the herd, and finally for the improvement of farming income.



**3.4 \_ Nir evolution**

**The power of the Internet of Things.**

The remote monitoring, diagnostics and calibration updates provided by Dinamica Generale improve your NIR analyzer performance by enabling our service personnel to remotely diagnose and proactively respond to any instrument issues.

When the NIR Evolution cloud software is initiated, the the analyzer’s performance data is sent to a secure cloud based system on a periodic basis. This allows our service support team the ability to immediately and proactively troubleshoot, diagnose, and help maintain the highest performance of your NIR instruments.

The Dinamica Generale Service department is responsible for monitoring the instrument’s critical operating parameters, allowing you peace of mind that your unit is always functioning according to our specifications.



**Features**

- Ensures EvoNIR analyzer up-time and accuracy
- Enables remote monitoring and diagnostics from almost anywhere in the world
- Decrease total cost of product ownership
- Reports historical performance data

**Main benefits:**

- Proactive problem detection and automated service initiation
- Decrease time for troubleshooting and diagnosis
- Remotely controlled resolution of problems
- Less time spent on the phone with service personnel
- Version control of calibration curves, software and firmware for the best NIR prediction

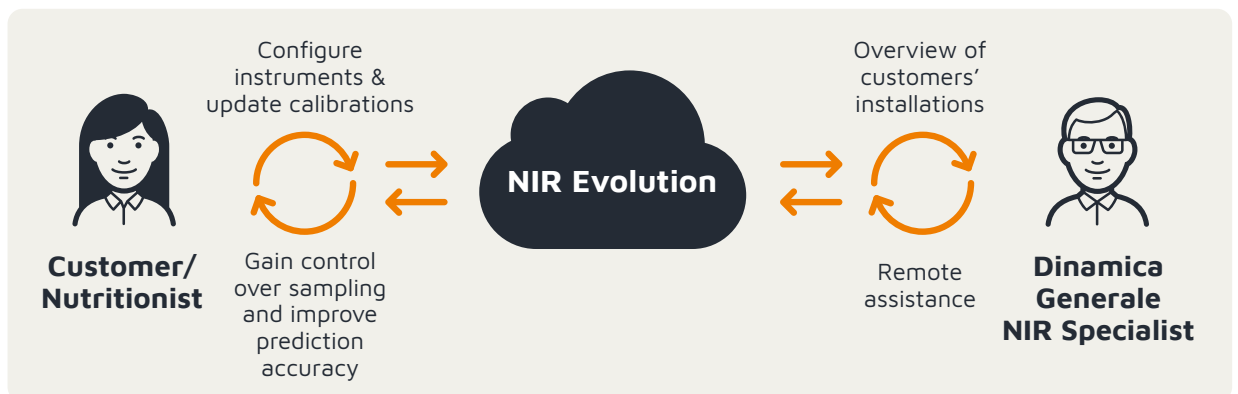

# 4. FEEDING MANAGEMENT SOFTWARE



### 4.1 \_ DTM software

#### YOUR FARM'S DATA HAS A STORY TO TELL...

DTM is a cloud based professional feeding management software that drives your precision feedingsystem. The comprehensive program helps farmers monitor and control feed costs, inventory, ration adjustments, feed efficiency and other critical on-farm processes like feeder performance.



#### CONNECTED FARM

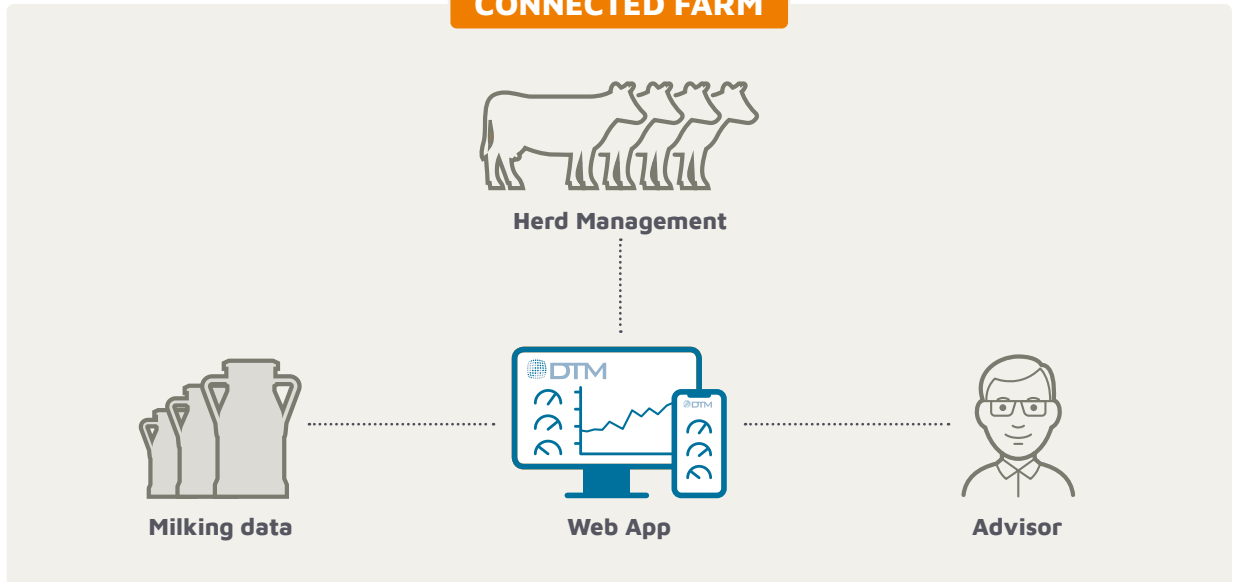

**Easy setup and management**



**Become more profitable and efficient**



**Stay always connected**



### Manage Feeding Plans

1



Eliminate paper feed sheets

- 1 Create ingredients and pens
- 2 Manage rations and pens
- 3 Set up your TMR mixers and monitor working time

### Transfer data

2



### Check Live Reports

3



Components consumption



NIR Data



Dry matter intake / cow



Create your custom report

**DTM Core advanced**



Software solution **developed** to manage **medium farms daily** operations

**DTM Core professional**



Software solution **developed** to manage **large farms daily operations** and **contractors**

**DTM Core IC**



The most complete feeding management software solutions **designed for structured** and **demanding farms**



**Compare DTM versions**



**Cloud based software**



**Reports**



**Stock management**



**Improve feed performance**

Integrate your herd management software to automatic import milk and cows data. Live reports on feed efficiency and IOFC.



## 4.2 \_ DTM Core App

DTM CORE Application communicate with DTM Cloud Software to perform quick changes to feeding operations and provides advanced feeding performance monitoring. The App detects each phase of the feeding process making farm managers promptly intervene before critical situation appear.

With DTM App, dairy beef farmers take decions that positively affect future performance. Automated reports save time and effort because always available at fingertips.

DTM CORE App will upgrade your DTM CORE capability giving you the possibility to perform changes on the fly right in the barn.



### CUSTOMERS' BENEFITS

- Change cows number and pen weight adjustment on-the-go.
- Sync wirelessly with your DTM Core Cloud and update each weight indicator in the farm.
- Input feed refusal for each pen and become more efficient.



Pen adjustment form



Synchronization



Feed refusal

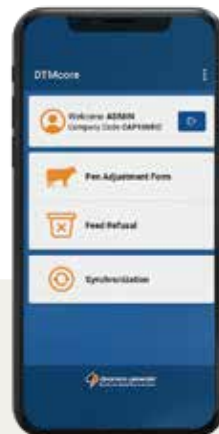



### Data Management



### IoT Gateways

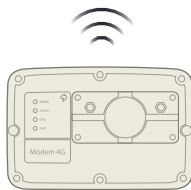

#### Modem 4G

##### Compatibility with:

DG600, DG8000-IC

4G Modem allows to transfer data from the weight indicator to DTM software without any limit of distance. Background synch allows to always have updated information for real time data-driven decisions.

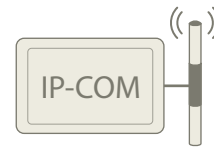

#### WiFi\_IP COM Kit

##### Compatibility with:

DG8000, DG8000-IC

Transfer your data wirelessly even without a mobile network in the farm. IP COM solution gives the farmers the possibility to exchange data between the scale and the software in a range of 800 mt.



### Applications

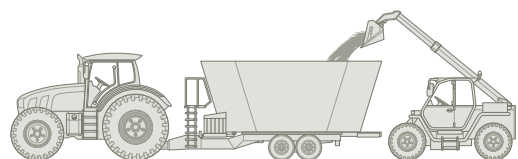
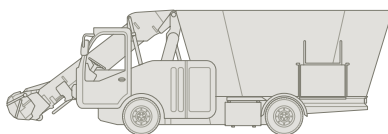



**DINAMICA GENERALE S.p.A.**  
Via Mondadori, 15 - 46025 Poggio Rusco MN - ITALY  
[dinamicagenerale.com](http://dinamicagenerale.com)

