



**IN FIELD
SOLUTIONS**

1. Introduction

- 1.1 Game-changing technology for smart farming
- 1.2 Precision Agriculture: the future of farming

2. Weighing technology

- 2.1 Sensors and load cells
- 2.2 Available configurations
- 2.3 SensorLogic

3. Field operation monitoring

- 3.1 DG400/SB-ECU Field Computer
- 3.2 Kali Connection Hub - Advanced Connection Platform
- 3.3 Accessories

4. EvoNIR analyzer

- 4.1 EvoNIR from the specialists in NIR technology
- 4.2 6-in-1 sensor

5. Precision Agriculture Solutions

- 5.1 Combine
- 5.2 Forage Harvester
- 5.3 Forage Wagon
- 5.4 Baler
- 5.5 Grain Cart
- 5.6 Slurry Tanker
- 5.7 Manure & Mineral Spreader
- 5.8 Traceability of grain process
- 5.9 Optimize farming processes using real-time data
- 5.10 Precision farming mobile applications

6. Portable analyzers for forage, silage, grain and slurry

- 6.1 AgriNIR portable analyzer
- 6.2 X-NIR handheld analyzer
- 6.3 Trustworthy NIR calibrations. Get better results. Simply

7. Smart connectivity and Data management

- 7.1 IoT Gateway
- 7.2 Field trace
- 7.3 NIRevolution

8. On-board Optical Sorting

- 8.1 Optical sorting technology for tomato and potato

Game-changing technology for smart farming

The way farmers, growers and contractors run their operations is changing. Connected machines, real time data-driven decisions are playing a key role in enhancing productivity, profitability and sustainability. Dinamica Generale precision agriculture solutions are designed to boost productivity, yields and quality.

Why Dinamica Generale technology is the right choice?



EXPERIENCE YOU CAN TRUST

Advanced NIR technology	Industry-leading NIR solutions, tried and tested analyzers for forage harvesters, combines, slurry tankers, balers, and portable analyzers.
Uncompromised service reliability	Dedicated customer service and support specialists fluent in multiple languages providing customer support at any time via phone, ticketing system, e-mail and chat.

ENHANCED CONNECTIVITY

State-of-the-art networking and connectivity	IoT gateways connect machines to cloud software to deliver safety, reliability and operational efficiency
Software Integrations	The automatic real-time interface between Dinamica Generale software and third party Farm Management Information Systems (FMIS) empower growers and farmers to maximize their daily job

UNRIVALLED SOLUTIONS CAPABILITY

In-house design and testing	A global team of engineers and IT professionals working to deliver the most reliable and flexible solution to meet customers demand
In the field support	Sales and technical engineers available to help customers solve on-site issues when they occur and gather specific needs to constantly improve products

1.1 _ Precision agriculture: the future of farming

OUR INNOVATIVE APPROACH TO PRECISION AGRICULTURE MARKET

Dinamica Generale is aiming at developing innovations, introducing new pioneering solutions to save costs, and reducing environmental impact.

We spend more than 10% of our revenue on R&D each year and our company is set up with a value driven, flat organization and independent teams, run projects from start to finish.

Our objective is helping farmers and growers to produce more and better food. The precision agriculture technology developed by Dinamica Generale are mainly upon a combination of weighing and connected sensors, NIR analyzers and cloud software.



Why choose us?



TRACEABILITY

Dinamica Generale technology can make a significant contribution to food traceability offering innovative solutions to trace all production from field, to farm, to fork.

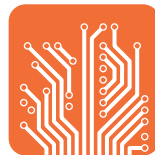

TECHNOLOGY

Connected sensors technologies are already widely available. Dinamica Generale is influencing work practices and new business models



SUSTAINABILITY

Dinamica Generale promotes more sustainable ways of farming: NIR sensor technologies and cloud software are already in use since many years with positive impacts on environment and productivity gains based on clever ways to track and use data.



SERVICE & SUPPORT

Precision agriculture requires the learning of new skills every day. Dinamica Generale's engineers are well trained to face:

- Complex OEM's requirements
- The wide diversity of farming practices worldwide
- Challenging applications
- Customized projects

PRECISION FARMING MARKET

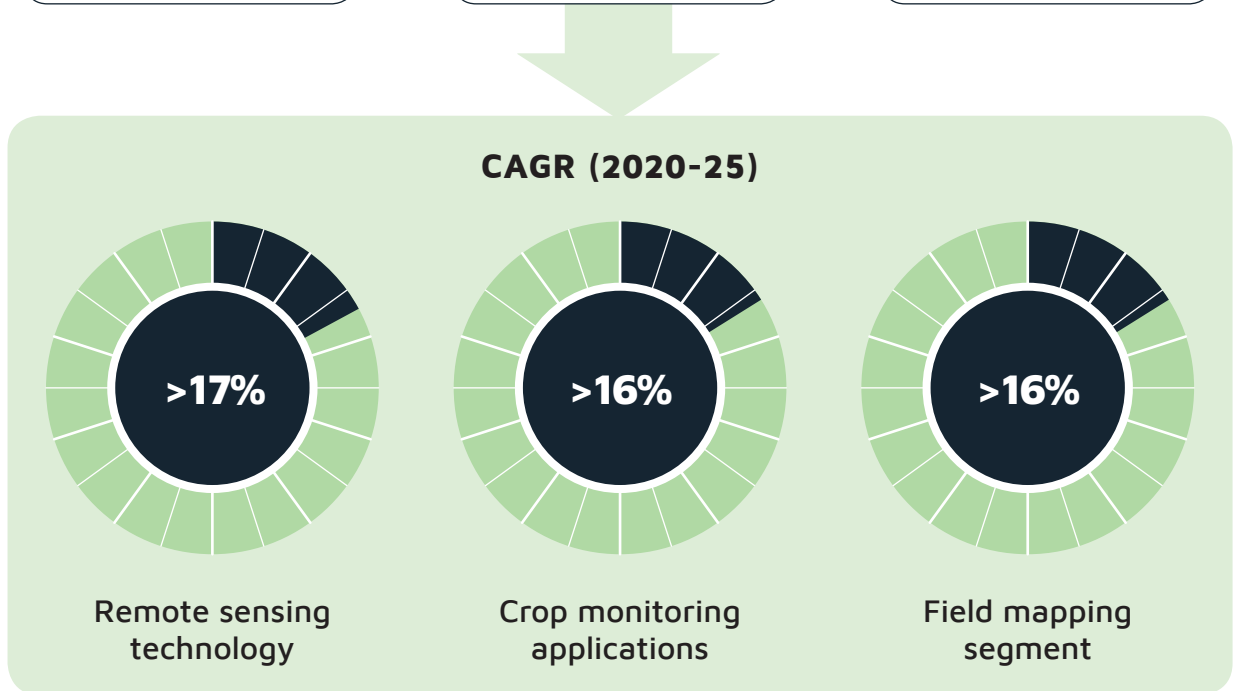
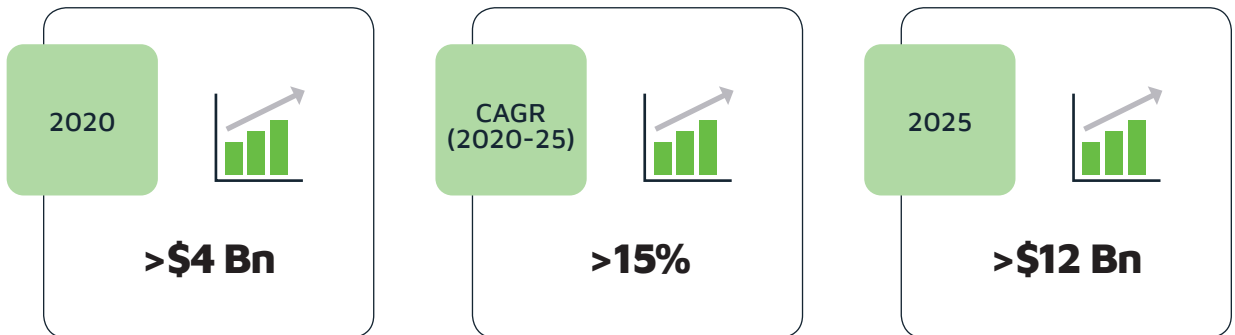

NA industry share by 2025:

>32%

LATAM market CAGR (2020-25):

>18%

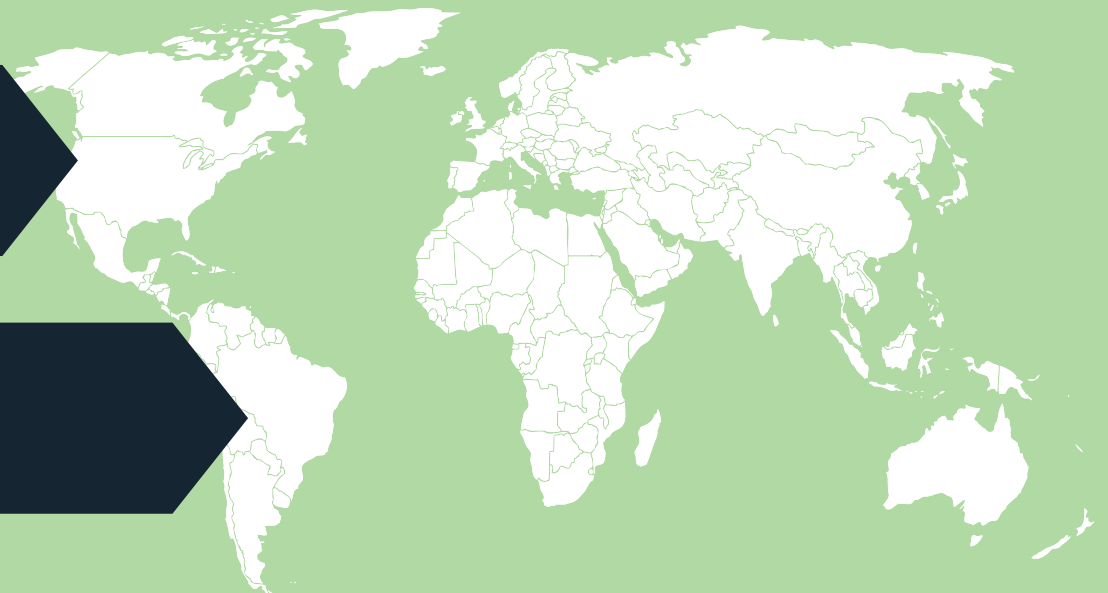

WEIGHING TECHNOLOGY



2.1 _ Sensors and load cells

Choose from multiple configurations and sizes, but never compromise on precision and reliability, which are standard in each load cell manufactured by Dinamica Generale.

We have been producing load cells since the nineties to meet our customer requirements. Even though we have an extensive product offering, if you cannot find just what you are looking for, we will work with you to develop a new product to suit your needs.

Dinamica Generale offers a comprehensive range of weighing sensors for agricultural applications such as grain carts, forage wagons, trailers and manure-mineral spreaders. For all machines, we supply sensors, junction boxes, cables. If necessary, we also offer systems that are tailored to special applications.

Common load cells specs

- Full traceability of each sensor
- Factory standard pre-calibration and testing procedures
- High accuracy
- Wide range available
- TPE cables: maximum protection against moisture, flame and temperature (operating temperature -50° C ~ 90° C)
- Sealed strain gauges: sealing agent and industrial grade potting compound protect against harsh use in agricultural field
- IP68 Protection rate
- Custom mechanical design available on request

Connectors and junction boxes

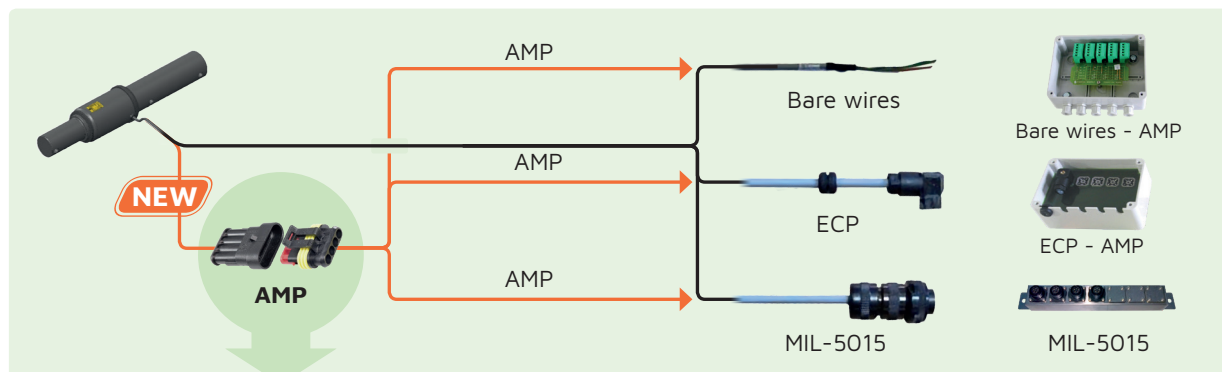

Easy installation:

- Load cells with AMP connector can be easily installed thanks to minimum cable length (only 10 cm - 4")
- The risk of accidentally cutting the cable during installation is minimized

Cost saving:

- Quick cable replacement reduces downtime of the machine to virtually zero
- In case of cable break down during field operations, only the cable is replaced instead of the load cell

Standard cable length m (ft):

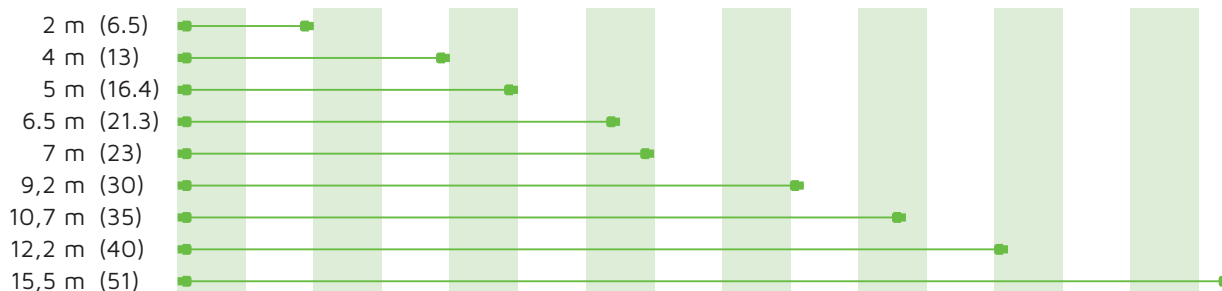



MOBILE

Robust heavy-duty Mobile load cell manufactured from treated alloy steel for on-board weighing. Typically installed on the hitch of trailers and fixed to the chassis.

Applications:

Forage Wagon, Feed Mixer, Grain Cart, Trailer, Baler, Bale Wrapper, Seed Tender, Manure and Mineral Spreaders, Compactors and all farm machinery in motion.

Features

- High-quality alloy steel: dinamica generale special thermal treatment makes it stable for years
- High resistant coating (480h salt spray testing)
- Aluminum protection: strain gauge protected against impact and moisture
- Temperature compensation as option

Dimensions and capacity

MOBILE	diameter mm (in)		capacity Kg (lb)	
	MIN	MAX	MIN	MAX
	25 (0.98)	95 (3.74)	315 (695)	15.000 (33,069)

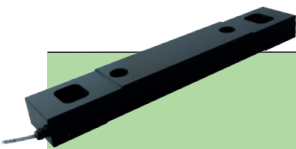

FLAT

Flat load cells designed for on board weighing applications. Typically installed in the underbody between tank and chassis or on single point suspension.

Applications:

Dump bodies (Tipper Trucks), Tankers, Forage Wagon, Grain Cart, Trailer, Manure Spreader, Refuse collection trucks.

Features

- Designed for on-board vehicle weighing
- Easy to install as a retrofit for aftermarket applications
- Available with high-resistant coating (480h salt spray testing) or nickel plated coating
- Temperature compensation as option
- Custom mechanical design available on request

Dimensions and capacity

FLAT	length mm (in)		capacity Kg (lb)	
	MIN	MAX	MIN	MAX
	240 (6.096)	450 (17.72)	5.000 (11,023)	20.000 (44,092)

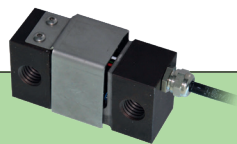

STRAIN SENSOR

Strain sensors measure deformation and stress of structures. They are applied to weigh and control overloads.

Features

- Measuring of tension/compression strain of the body where it is fastened
- High sensitivity to small stress
- Easy assembly and disassembly (no drilling nor machining is required on structures)
- Designed for various applications (axle weighing, overload control, structures stress/strain monitoring)

Dimensions and capacity

STRAIN SENSOR	Measurement range
	±500 µm/m

Applications:

Trailer, Manure Spreader, On-board Truck Weighing in general



Applications:
Feed Mixer, Forage Wagon, Trailer, Baler, Hay Bale Wrapper, Seed tender, Fertilizer and Mineral Spreader, Compactor

DRAW BAR

Robust heavy duty load cell manufactured from alloy steel for on-board weighing.

Features

- Specifically designed for flange towing eyes, it can be applied to factory-mounted or retrofitted equipment
- Typically installed on forage wagons, spreaders, grain carts and other on-board trailed applications

Dimensions and capacity

DRAW BAR	capacity Kg (lb)	
	MIN	MAX
	4.000 (8,818)	10.000 (22,045)



Applications:
Forage Wagon, Feed Mixer, Grain Cart, Trailer, Manure Spreader.

COMPRESSION

With rated loads ranging from 13t to 22t Dinamica Generale compression load cells are applicable for a variety of agricultural and on-board applications

Features

- Designed for high capacity stationary/mobile applications (grain carts, weighbridges, silos)
- Aluminum protection: strain gauge protected against impact
- Temperature compensation as option

Dimensions and capacity

COMPRESSION	dimensions mm (in)		capacity Kg (lb)	
	LENGTH	DIAMETER	MIN	MAX
	108 (4.25)	73 (2.87)	13.608 (30,000)	22.680 (50,000)

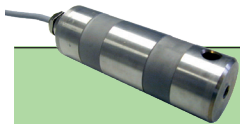

Applications:
Tipper Trucks, Forage Wagon, Grain Cart, Manure Spreader.

PIN

Hinge pin load cells for real time monitoring of load forces. Typically installed at the rear hinge pivots of tipper trucks

Features

- Ideal as a retrofit, pin load cells can be easily integrated in aftermarket equipment without taking up space (such as dump truck pivot hinges)
- Suitable for a variety of applications (pulleys, shackles etc.)
- Manufactured from 17-4 PH Stainless Steel that provides an outstanding combination of high strength, good corrosion resistance and good mechanical properties

Dimensions and capacity

PIN	diameter mm (in)		capacity Kg (lb)	
	MIN	MAX	MIN	MAX
	35 (1.38)	60 (2.36)	3.000 (6,614)	10.000 (22,046)

2.

WEIGHING TECHNOLOGY

2.2 _ Available configurations

Underbody mounts

Typical application with load cells installed between the body (tank, bin) and the chassis of the vehicle; in this type of mounting, the load cells carry the weight of the container and its payload.

To get optimum system performance, no other elements must bypass the load cells in connecting the tank and the frame underneath. Extraneous elements (rigid piping, pressure retaining cylinders...) may affect the accuracy of the weighing.

Typical Application: trailers, grain carts, forage wagons, manure spreader

Solutions

Solution 1

Type: Mobile load cells
Range of capacity: 1-10 t



Solution 2

Type: Flat load cells
Range of capacity: 10-20 t

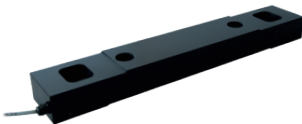

Solution 3

Type: Compression load cells
Range of capacity: 15-23 t



Typical installations

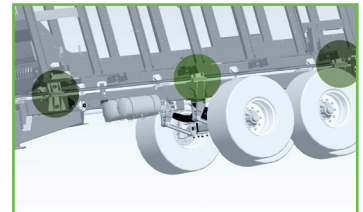
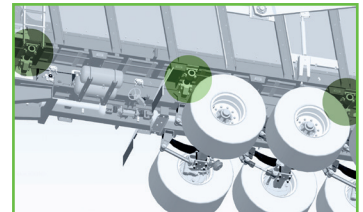

Spring suspension mount

Installation of flat load cells on single point trailer suspensions under the leaf springs (between the axle and the body/tank). Mounting plates can be optionally be provided, conveniently adapted to fit the axle design. This installation requires an additional load cell on the drawbar and the use of a SensorLOGIC box.

Typical Application: trailers, manure spreaders

Solutions

Solution 1

Type: Flat load cells
Range of capacity: 10-20 t

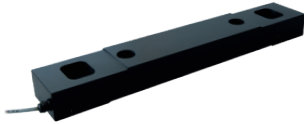

Type: Drawbar
Range of capacity: 1-10 t

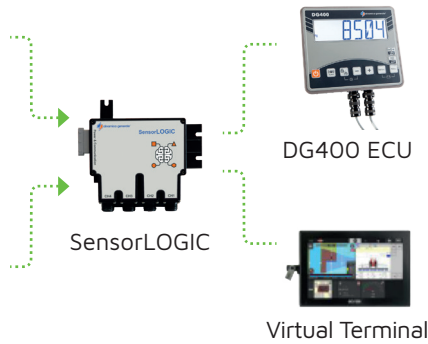

Typical installations

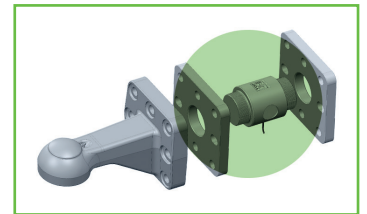
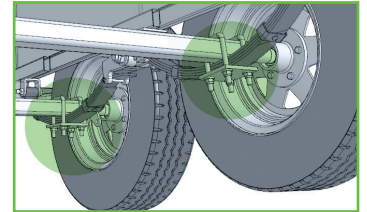

Dump body mounts

Option 1: "Body rest" - Hinge pivot

Typical installation on dump trucks using pivot "pin" load cells at the rear hinge points. The design of these sensors can be customized to fit specific hinges. The load cell replaces the pin without mechanical works on the machine body. The same result can be achieved by installing flat load cells between the rear bearing assembly and the underside trailer mount.

Typical Application: trailers, grain carts, forage wagons, manure spreader

Solutions

Solution 1

Type: Pin load cells
Range of capacity: 5-10 t



Solution 2

Type: Flat load cells
Range of capacity: 10-20 t

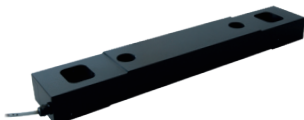

Typical installations

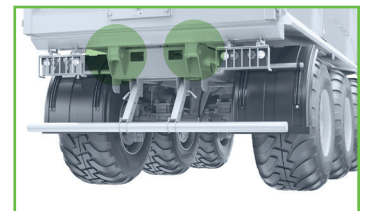

Dump body mounts

Option 2: "Lifted tank"

Typical installation on dump trucks using pivot "pin" load cells at the rear hinge points. The design of these sensors can be customized to fit specific hinges. The load cell replaces the pin without mechanical works on the machine body. The same result can be achieved by installing flat load cells between the rear bearing assembly and the underside trailer mount.

In the "lifted tank" installation, it's suggested to mount pin or flat style sensor under the hydraulic cylinder. As a second option in case load cells can't be installed, a pressure sensor can be used.

Typical Application: trailers, grain carts, forage wagons, manure spreader

Solutions

Typical installations

Solution 1

Type: Pin load cells
Range of capacity: 5-10 t



Solution 2

Type: Flat load cells
Range of capacity: 10-20 t

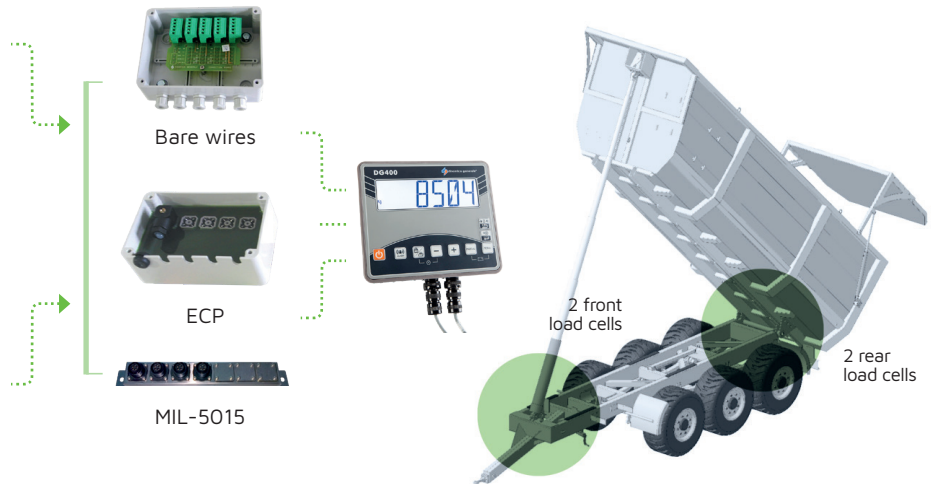
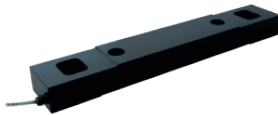

Solution 3

Type: Pin load cells
Range of capacity: 5-10 t
+
Type: Pressure transducer
Range of capacity: 250/500 bar



Solution 4

Type: Flat load cells
Range of capacity: 10-20 t
+
Type: Pressure transducer
Range of capacity: 250/500 bar

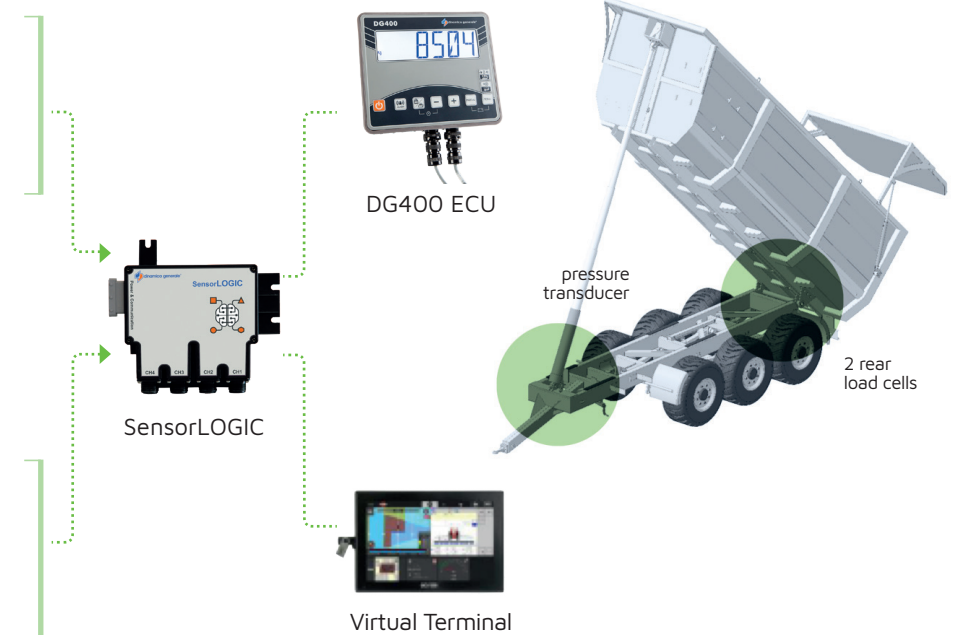
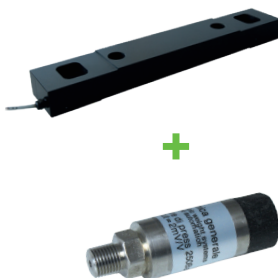

2.3 _ SensorLogic

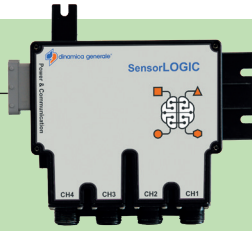

SENSOR LOGIC

Intelligent ECU that offsets and converts different analog input signals from different weight sensors into a CAN protocol (J1939 and ISOBUS).

Typical applications: mineral fertilizers, balers, grain carts, forage wagons, etc

Features

- Calibration software developed on PC platform
- Supporting up to 4 different input channels
- Harsh environment resistant
- Waterproof
- Integrated support brackets

Benefits

- Rapid programming and calibration via PC
- Easy and quick installation
- Versatile connection
- Accurate single-sensor calibration
- Single-sensor assistance (sensor remote assistance available with modem installed)

Operating temperature	-30°C / +60°C
Power supply	9,5 - 32 Vdc
Dimension	200 x 187 x 47 mm
Weight	1000 gr (2,2 lbs)
Case	PA66+GF (completely resinated)
Output protocols	CANJ1939 and ISOBUS
Input	4 independent channels (possibility to connect more load cells in parallel)
Calibration	Multi Sensor PC Software (possibility to calibrate load cells singularly)
Diagnostic	Multi Sensor PC Software (quick diagnostic of the load cells)

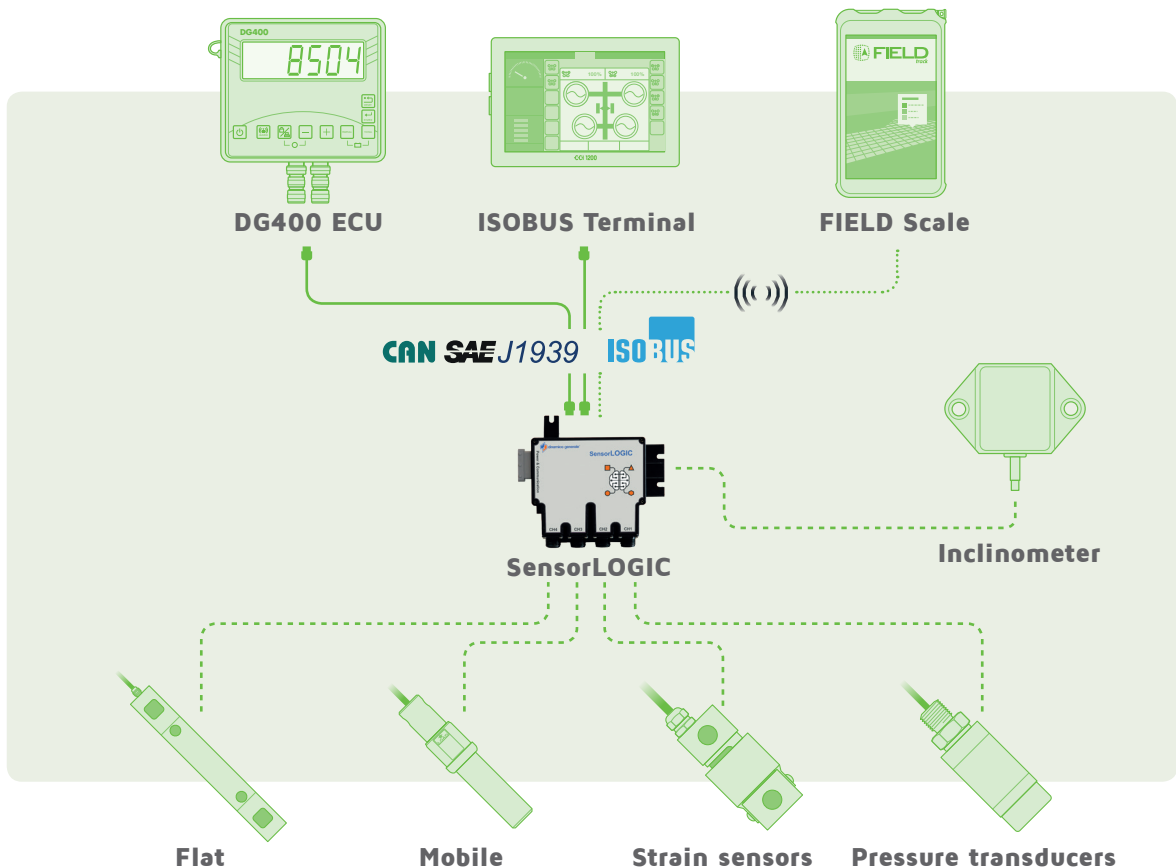



FIELD OPERATIONS MONITORING

3.

FIELD OPERATION MONITORING

3.1 _ DG400/SB-ECU Field Computer

Dinamica Generale precision farming technology gives greater control over your field. Select the system that meets your specific needs. Or build a precision farming system perfect for your operation, with:

FIELD COMPUTER

DG400/SB-ECU. The in-cab “brain”, with easy-to-read display, intuitive menus and simple operation control.

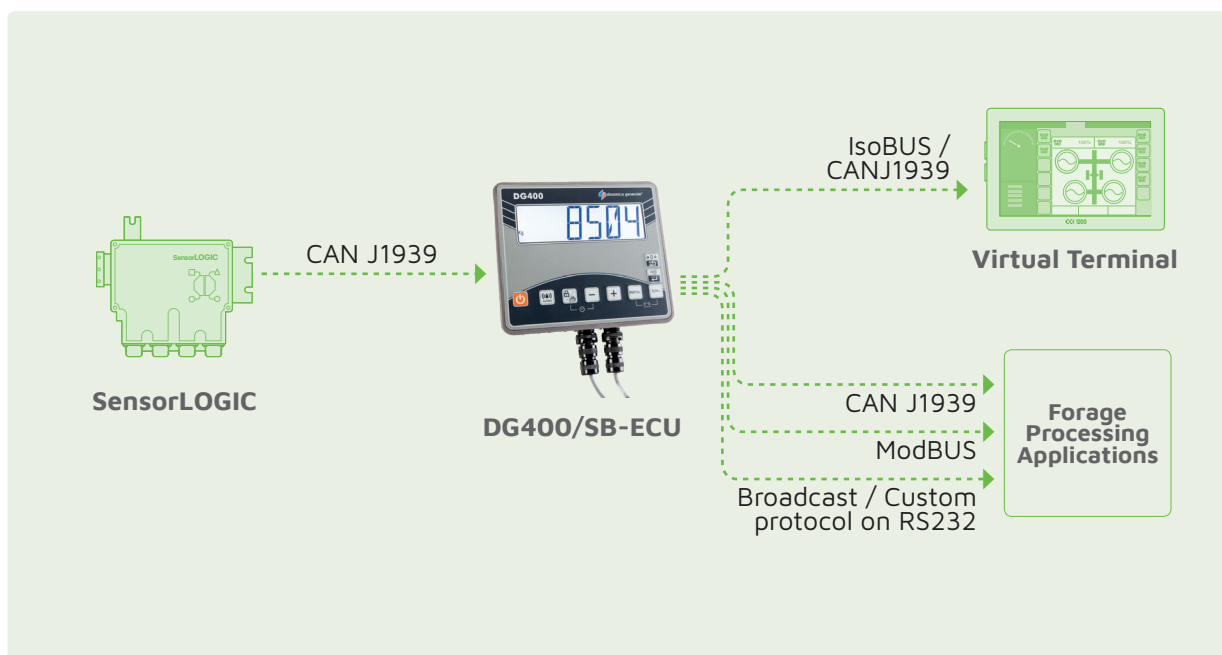

Model	DG400 / SB-ECU
Description	Digital weighing indicator that gathers signals from different load cells to provide accurate output in ISOBUS and CANJ1939 communication protocol
Benefits	<ul style="list-style-type: none"> • Easy to use with quick access to all functions • Perfect reading at every moment of the day, under the sun/rain • Safe usage at any weather condition and temperature • Balanced price-performance ratio • Flexible and reliable. Functions and configuration of DG400/SB-ECU weight indicator can be easily tailored to users' needs
Features	<ul style="list-style-type: none"> • Overload control for improved operator security • Working mode: total/partial and net/gross weight • WiNET port for plug & play connection of ALL accessories • All models of load cells can be connected • Equipped with ISOBUS and CANJ1939 communication protocol as standard
Applications	The DG400/SB-ECU can be used in applications such as slurry and fertilizer spreaders, balers, seed tenders, forage wagons, grain carts

3.

FIELD OPERATION MONITORING

3.2 _ Kali Connection Hub - Advanced Connection Platform

Kali Connection Hub is the breakthrough platform that combines our most advanced software, hardware and connection capabilities into a one-stop solution.

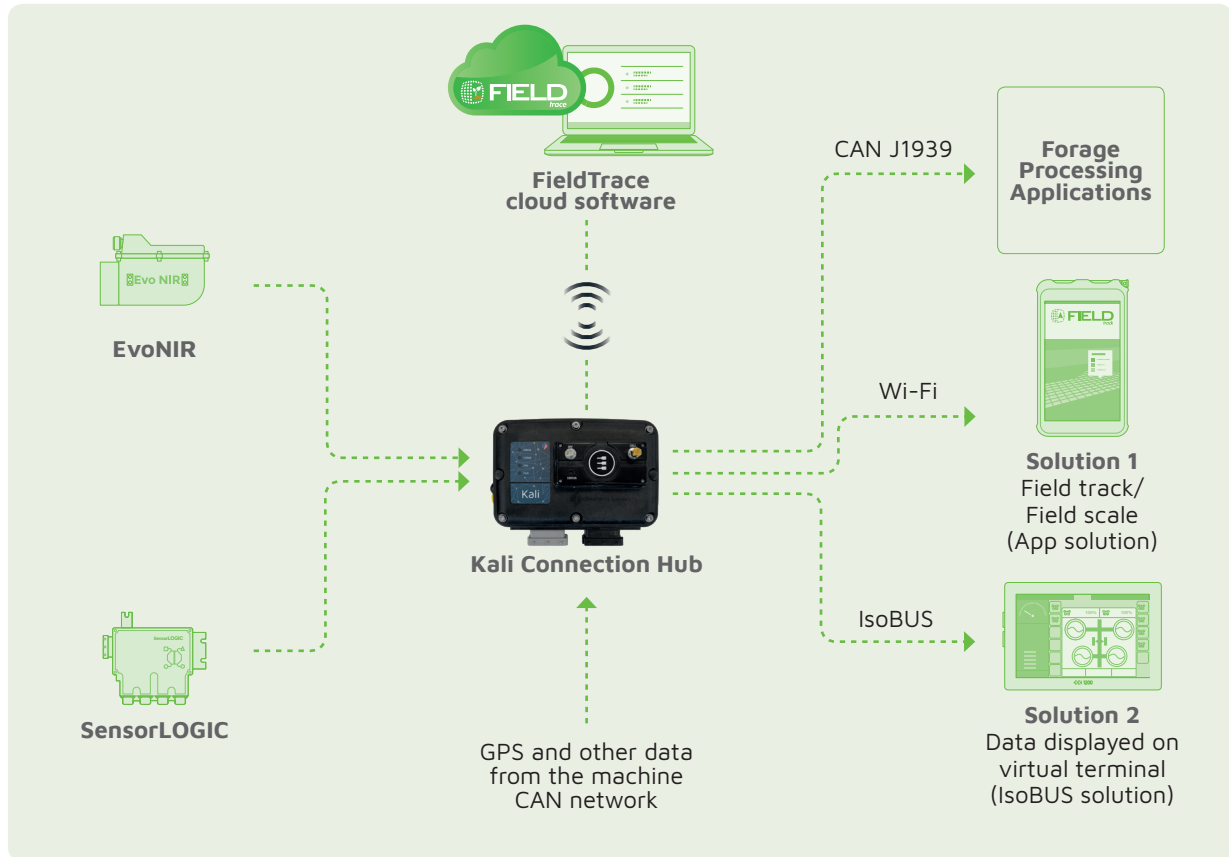

Model	Kali Connection Hub
Description	Kali Connection Hub syncs and connects different platforms such as EvoNIR sensor, Field track/Field scale app, GPS antenna, Virtual Terminals to name but a few
Benefits	<ul style="list-style-type: none"> • Integrated 4G high-speed modem for uncompromised connectivity and real time data sharing • Remote serviceability • Multi-platform compatibility: Field track/Field scale app, EvoNIR, Virtual terminals, GPS etc. • Proven performance in the most challenging field areas • Download software and calibration curves update for EvoNIR sensor remotely • Expandable multi-sensor system architecture
Features	<ul style="list-style-type: none"> • Built-in WiFi modem for smooth connectivity with Field track app • Data exchange between Kali Connection Hub and yield sensors or flowmeters via CAN bus networks • 3 CAN bus Inputs • Faster file transfers and software updates • ISOBUS-J1939 standard communication protocol
Applications	Kali Connection Hub can be installed on forage harvesters, combine harvesters, slurry tankers, forage wagons, grain carts.

3.3 _ Accessories

Remote Displays

Indicators' Compatibility: DG400/SB-ECU - Compactor Scale - FIELD Scale

**Extra Display**

LED Display to control weight and components even from long distance (over 30 m - 100 feet). High performance display even in direct sunlight.

Display: LED Matrix panel 60 mm (2.4 inches)

**Weight Repeater**

High efficiency LED display to be visible in any lighting conditions. Clear and comfortable viewing of weight information from any position. Lower energy consumption. Shorter set-up time and easy connection to the weight indicator.

Display: Red "diodes LED" display 60 mm (2.4 inches)

Printer

Indicators' Compatibility: DG400/SB-ECU - FIELD Scale - NIR On Board



Description	Records on a ticket the information about weight loaded or analysis saved on the weight indicator. Possibility to print the strings in the languages that are available on the indicator.
Benefits	<ul style="list-style-type: none"> • Easy tickets' personalization • Flexible and quick connection to Dinamica Generale weight indicators • Reduced maintenance costs
Features	<ul style="list-style-type: none"> • Product conforms to EEC directives • During manual operations, current weight value (TOTAL and/or PARTIAL) with date and time can be printed by simply pressing the PRINT key

GPS Antenna

Indicators' Compatibility: FIELD Scale - NIR On Board - GEOSpreader - GEOSystem



Description	Compact GPS receiver compatible with main Dinamica Generale field operation indicators
Benefits	<ul style="list-style-type: none"> • Highly compact and shock resistant • Flexible and quick connection • High Performance, Reduced System Power and Cost
Features	<ul style="list-style-type: none"> • Support GPS, GLONASS, GALILEO and QZSS • Capable of receiving data from SBAS (WAAS, EGNOS, MSAS, GAGAN) • Support 99-channel GNSS • Built-in data logger • Up to 10 Hz update rate • Waterproof



THE SPECIALISTS IN NIR TECHNOLOGY

Dinamica Generale has developed NIR technology systems since the year 2000. Thousands of installations worldwide, vast on-site, real time analysis experience and internal calibration curves generation capabilities are the foundation of our success.

Farm managers, nutritionists, biogas plant owners, growers and contractors, to name a few, are using Dinamica Generale NIR analyzers worldwide to make intelligent decisions and take immediate, effective actions to optimize profits.



4.1 _ EvoNIR from the specialists in NIR technology

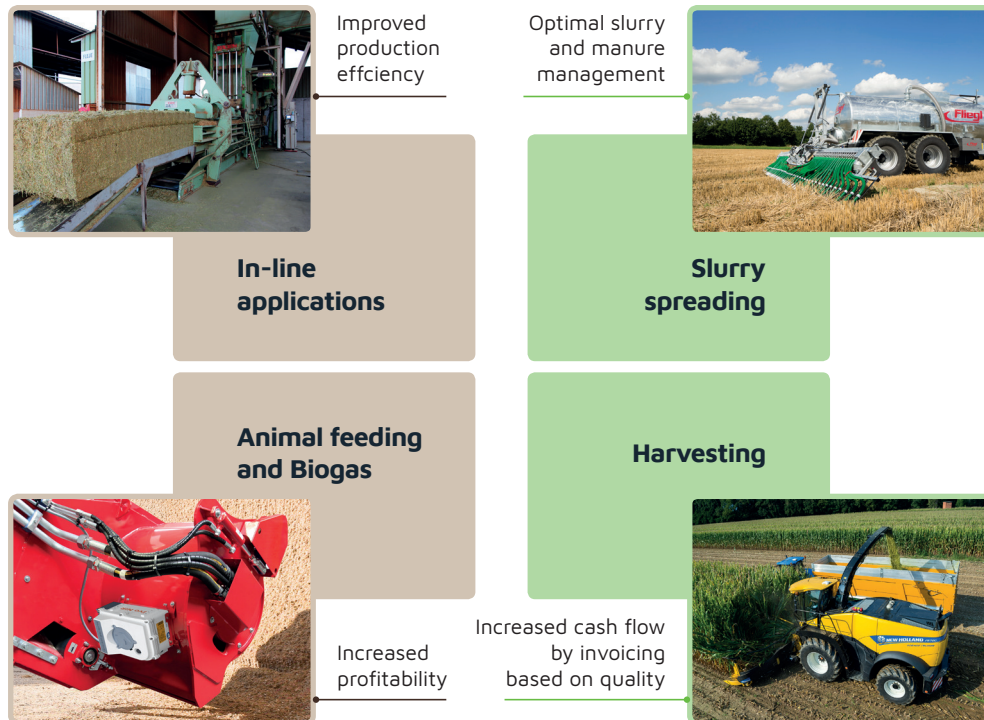

**THE COMPETITIVE ADVANTAGE OF DINAMICA GENERALE:
TURNING CUSTOMER EXPECTATIONS INTO EFFECTIVE SOLUTIONS**



Internal firmware
development
and deployment



In-house
development of
calibration curves



Internal hardware
design and Cloud
software development

Our strengths towards competition:

- A team of world-class talented engineers and mathematicians focused on NIR research and development.
- Thousands of samples collected worldwide and partnerships with main laboratories in 5 continents.
- Exclusive patents on different applications: automatic adjustment of the target weight for feedstuffs and water on feed mixers, NIR and Imaging analysis on harvesting machines.
- In-house lab for extensive calibration curve creation capabilities.
- Cloud based software for management of calibration curves

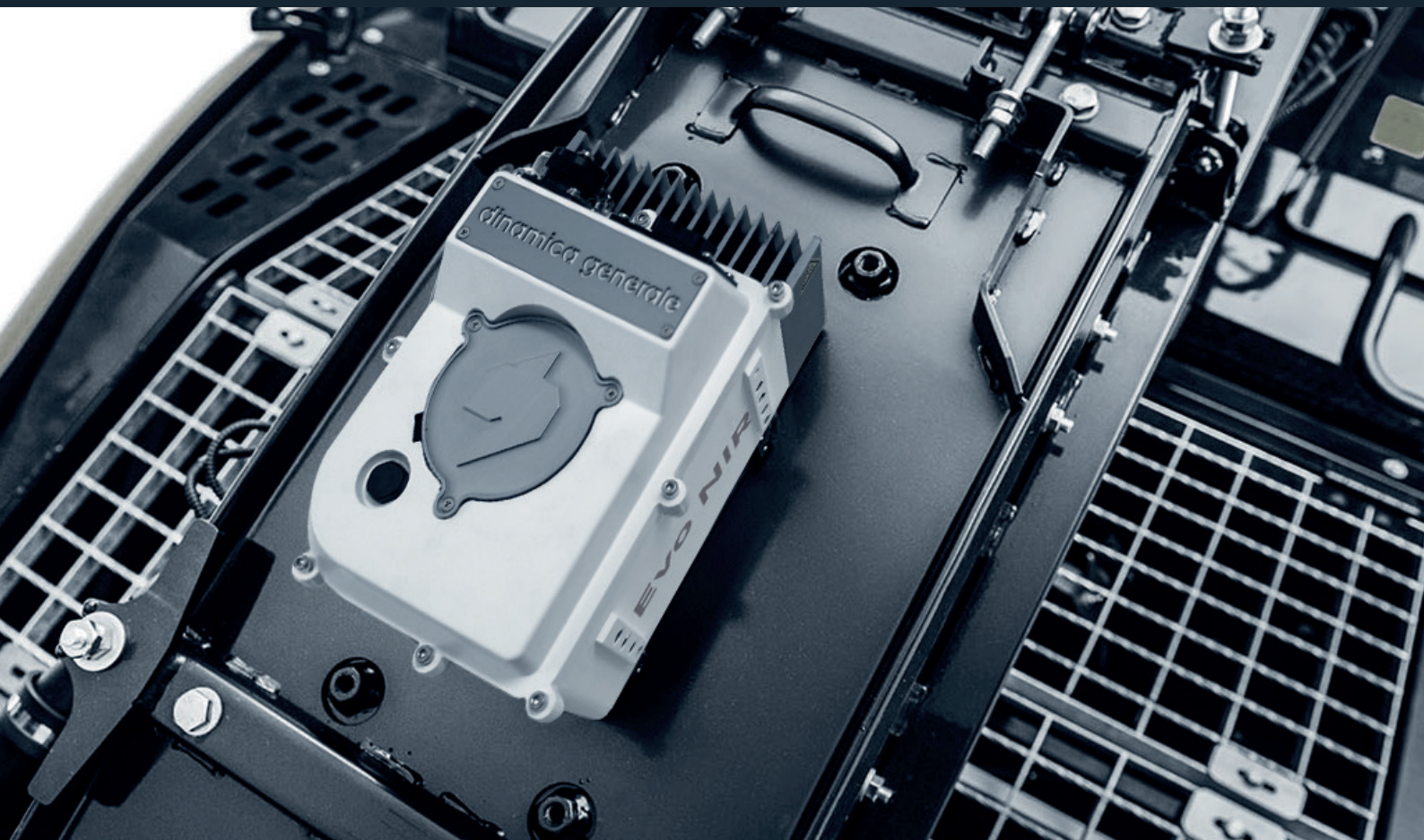

EvoNIR 4.0. Near perfection.

Whether your objective is growing, field fertilizing, biogas generation, or dairy production, precision is the keyword for successful farming.

With EvoNIR sensor technology, farmers, growers and contractors can achieve a new level of accuracy and efficiency with real time data directly in the field.

Mounted on agricultural machinery and feeding plants, EvoNIR is capable of measuring dry matter, protein, starch, fiber, neutral detergent fiber, acid detergent fiber, ash, sugar and many other nutrients in real time with outstanding accuracy.

INGRESS PROTECTION	IP69K
ACCURACY	Moisture (Max 2%)* - ADF, NDF, Starch, Ash, Crude Fat, Sugar, pH (Max 3%)*
POWER SUPPLY	12-32 V DC
WEIGHT	4kg
WORKING TEMPERATURE	-10°C, +50°C
CASE DIMENSIONS	171 x 233 x 174 mm
CASE MATERIAL	Aluminium
ISOBUS VIRTUAL TERMINAL COMPATIBLE	Yes
ISOBUS TASK CONTROLLER COMPATIBLE	Yes

* The degree of accuracy depends upon the availability of prediction models for each product, on-site verification of the instrument, use of the NIR Evolution Cloud Software

4.

EvoNIR ANALYZER

4.2 _ 6-in-1 sensor

The EvoNIR sensor can be mounted on forage harvesters, combines, balers, forage wagons, slurry tankers, compactors, feed mixers and portable in a carrying case.

The core of the system is the Evo NIR basic kit: only one part number for a streamlined supply chain management. Customers willing to install the EvoNIR onto their machines just need to add the specific application pack and use the sensor all over the year.

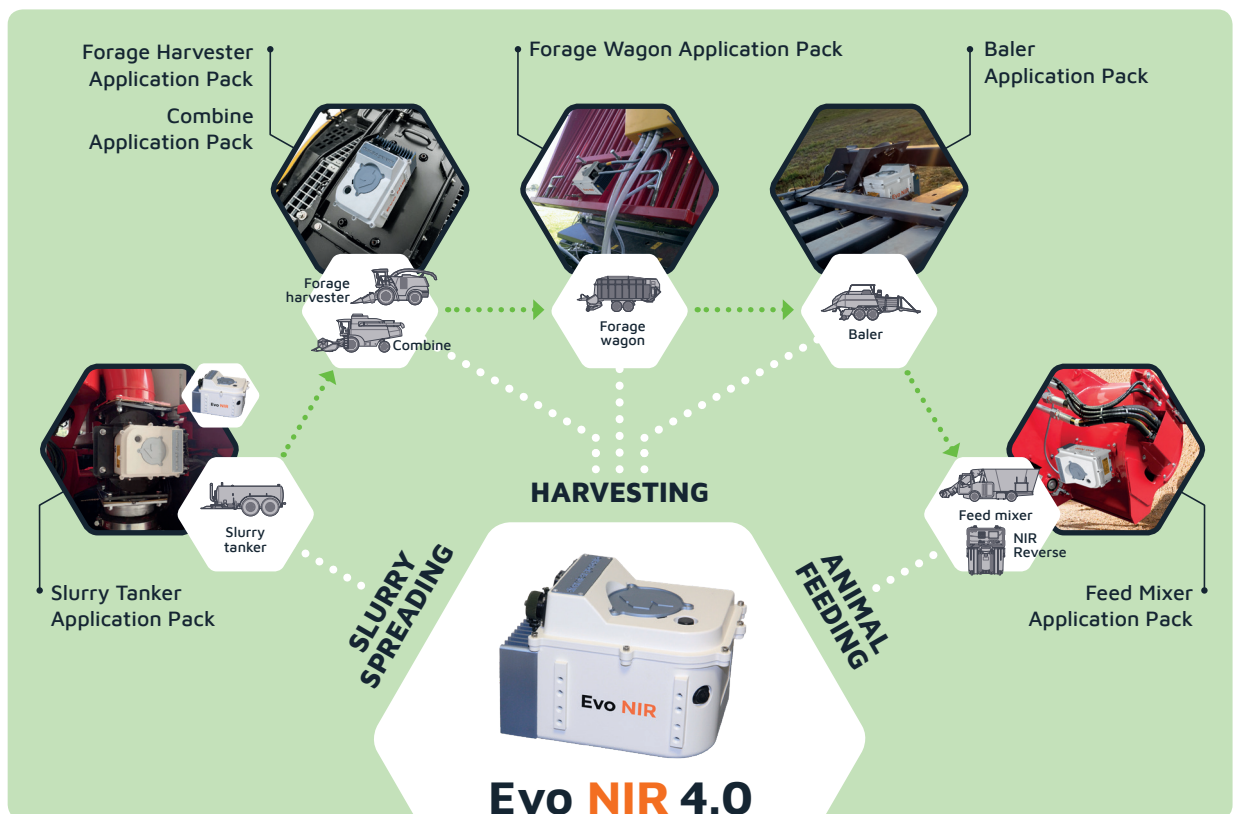

CUSTOMERS' BENEFITS

• **Crop growers:**

Detect plant disease in advance for more effective use of agrochemicals and a more sustainable method of crop management. Measure plant quality prior to harvest, during and after harvest.

• **Contractors:**

Provide additional services to customers by offering valuable crop analysis and yield maps. Make adjustments to chopper if excess ash is detected while harvesting.

• **Biogas plant owners:**

Biogas plants have DM based contracts with farmers and contractors that deliver either freshly chopped crops or silage. Perform constant monitoring of nutrients of what is being delivered ensures better plant performance.

Monitoring the level of nutrients in silage is a key factor to ensure an homogenous production of Biogas.

• **Dairy and beef farmers:**

Automatic adjustment of feed ration for dairy cows and beef cattle based on nutritional value to improve quality, production and profits.



PRECISION
AGRICULTURE
SOLUTIONS



Growers and contractors make many decisions during the harvesting season. Using Dinamica Generale precision Agriculture solutions job in the field become easier!

Solutions for accurate nutrient analysis and real time crop quality mapping

Aftermarket solutions	Forage harvester	Combine	Forage wagon	Baler	Grain cart	Manure spreader	Slurry tanker
NIR Analysis	●	●	●	●			●
Weighing			●	●	●	●	
NIR Analysis + Weighing			●	●			
Field trace Cloud software	●	●	●		●	●	●

What Dinamica Generale solutions can do for you:

- Instantly see crop quality map as you go across the field with the Field track app
- Improve understanding of productivity
- Gather more reliable data to understand how well your crop performed
- Decide how to store your grains and forages based on moisture readings in the field

The value of data

- Data from your field is an invaluable resource to help you make better management decisions.
- Overlay hybrid/variety maps with harvest maps to determine yield performance.
- Since Field trace software stores every year of information, you can see the history of yield trends.



5. PRECISION AGRICULTURE SOLUTIONS

5.1 _ Combine

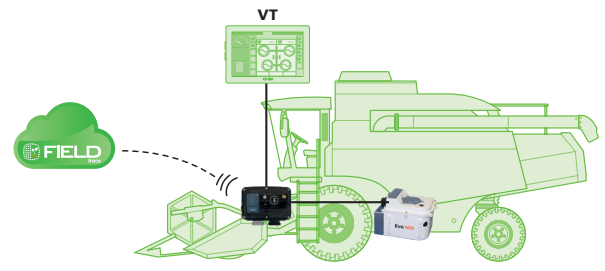

Technological solutions for forage harvesters

NIR analysis			
Solution	System configuration	Where applicable	Value for customer
EvoNIR + Kali Connection Hub + Virtual Terminal + Field trace		Installation on combine harvesters with Virtual Terminal	<ul style="list-style-type: none"> • Real time ingredient analysis • Standard ISOBUS/CAN connection • High speed data exchange • Real time nutrient concentration mapping on Virtual Terminals (with Task Controller) • Reports available in the Field trace software
EvoNIR + Kali Connection Hub + Field track app + Field trace		Installation on combine harvesters w/o Virtual Terminal	<ul style="list-style-type: none"> • Real time ingredient analysis • Real time nutrient concentration mapping on Field track app • Reports available in the Field track mobile app
EvoNIR + Kali Connection Hub + Field track app + Virtual Terminal + Field trace		Installation on combine harvesters with Virtual terminal (w/o task controller)	<ul style="list-style-type: none"> • Real time ingredient analysis • Real time nutrient concentration mapping on Field track app • Reports available in the Field track mobile app

CUSTOMERS' BENEFITS

- Compare hybrid variety productivity.
- Contractors: offer additional services.
- Crop Growers: optimize selling price of grain based on protein content.
- Get higher prices for grain being sold



Maximize grain harvesting

Small improvements in grain harvesting bring large increases in profits. This motto guides Dinamica Generale precision agriculture solutions dedicated for combine harvesters no matter the makes.

By combining ISOBUS NIR sensor, Kali Connection Hub, Field trace cloud software and real time mapping app we are capable of delivering unseen levels of performance.

TESTED NIR TECHNOLOGY

What is the crop really worth?

Growers and contractors can now measure the value of their crop according to precise real-time constituent's analysis of grain and oil seed. EvoNIR analyzer on combines and Field trace Cloud software are taking back control over the sale of grain to optimize income. Nevertheless, in-season crop constituent data mapping let farmers to accurately fertilize the next season.

Should I segregate and blend before delivery?

EvoNIR on combines properly controls grain segregation and blend in the field thanks to real time nutrients analysis and mapping. A few example below:

- **Dry Matter (DM)** – if average DM content is beyond 14% grain needs to be dried
- **Protein** – measuring protein level let farmers segregate grain for bread, pasta or animal feeding, etc
- **Gluten** – content of gluten influences the baking properties of flour. The gluten content let farmers segregate grain for bakery usage

Where should we start harvesting and when?

Advanced grain analysis supported by EvoNIR analyzer gives customers the key to determine when to harvest Thanks to EvoNIR the right timing of cutting can be easily determined analyzing dry matter content in a small portion of field.

Protein level %	Euro/t
13,61-14	219,35
14,01-14,20	222,23
14,21-14,49	226,08
14,50-14,99	275
15,00-15,49	280
Over 15,50 %	285

Operation	Euro/ha
Field preparation	100,00
Fertilizing	340,00
Seeds	220,00
Treatments with sprayer	110,00
Irrigation	60,00
Harvesting (contractor cost)	170,00
Other field works	26,00
Insurance	43,00
Taxes	120,00
Total Cost	1189,00

Why measuring protein content is key during grain harvesting?

Wheat grain sale price is different on the basis of protein content.

Considering a Wheat grain production of 6,5 t/ha on the tablebelow you can see how much important is NIR to optimize field treatments.

Production t/ha	Cost euro/ha	Sale price/t		Profit
6,5	1189,00	Protein %	Euro/t	Euro/ha
6,5	1189,00	13,61-14	219,35	236,80
6,5	1189,00	14,01-14,20	222,23	255,50
6,5	1189,00	14,21-14,49	226,08	280,50
6,5	1189,00	14,50-14,99	275	598,50
6,5	1189,00	15,00-15,49	280	631,50
6,5	1189,00	Over 15,50 %	285	633,50



5. PRECISION AGRICULTURE SOLUTIONS

5.2 _ Forage Harvester

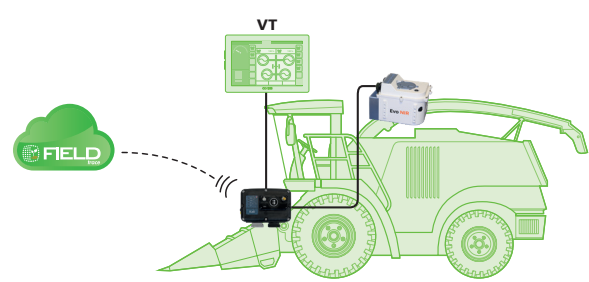

Technological solutions for forage harvesters

NIR analysis

Solution	System configuration	Where applicable	Value for customer
EvoNIR + Kali Connection Hub + Virtual Terminal + Field trace		Installation on forage harvesters with Virtual Terminal	<ul style="list-style-type: none"> • Real time ingredient analysis • Standard ISOBUS/CAN connection • High speed data exchange • Real time nutrient concentration mapping on Virtual Terminals (with Task Controller) • Reports available in the Field trace software
EvoNIR + Kali Connection Hub + Field track app + Field trace		Installation on forage harvesters w/o Virtual Terminal	<ul style="list-style-type: none"> • Real time ingredient analysis • Real time nutrient concentration mapping on Field track app • Reports available in the Field track mobile app
EvoNIR + Kali Connection Hub + Field track app + Virtual Terminal + Field trace		Installation on forage harvesters with Virtual Terminal (w/o task controller)	<ul style="list-style-type: none"> • Real time ingredient analysis • Real time nutrient concentration mapping on Field track app • Reports available in the Field track mobile app and on Field trace software

Harvest more value

Tracking the most accurate quality throughout harvest is what successful growers and contractors are aiming to. Dinamica Generale precision agriculture system is one of the most tried and tested technology that provides accurate results with different crops.

EvoNIR sensor takes the guesswork out for producing high quality silage with outstanding accuracy.

This valuable real-time information turns into excellent traceability, a great advantage for dairy farmers when preparing feed with mixers for their livestock or for sale. They will be able to precisely adjust rations in order to match their nutritionists' feeding recommendations. As a result, farmers will provide high quality feed every day with the consistency that is so important for livestock.

CUSTOMERS' BENEFITS

- Compare hybrid variety productivity.
- Forage Harvester optimization: adjust cutting length & inoculants application based on moisture level.
- Increase the profit negotiating the price by quality and not only by quantity
- Controlling nutrients in fields during harvesting enables to plan ahead specific actions (e.g. fertilization)
- Measure the value of starch contained in the harvested material enables making a prediction of gas production for biogas plants

Working Hard or Working Smart?

Every growers must plan their operations, track harvest accurately, and stay in tune with their crop inventory balances to be successful. Top growers using EvoNIR technology sustain their advantage over time, and these gains compound themselves because they find ways to keep improving efficiency.

Add to this, real-time measurement with Field track app gives you the control of quality map in real-time from your mobile.

Main advantages of real time quality mapping:

- transforming the way farmers manage their feedstocks and plan their future choice of crop varieties.
- The data collected by the EvoNIR system are quickly transferred to the app wirelessly. Here with Field trace Cloud Software you can easily print statistics, compare crops year after year, review performance thanks to many reports available.

Some of the main crops that can be measured quickly and accurately right in the field with our calibrations:

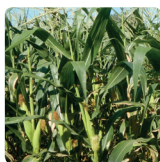

Green maize

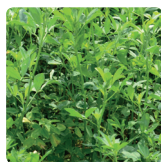

Green alfa alfa

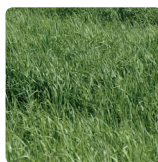

Green grass



Green triticale



Earlage

For each ingredient, in addition to dry matter content, EvoNIR predicts crude protein, starch, ash and fiber (ADF/NDF, which are important nutrient factors in livestock feed).



5. PRECISION AGRICULTURE SOLUTIONS

5.3 _ Forage wagon

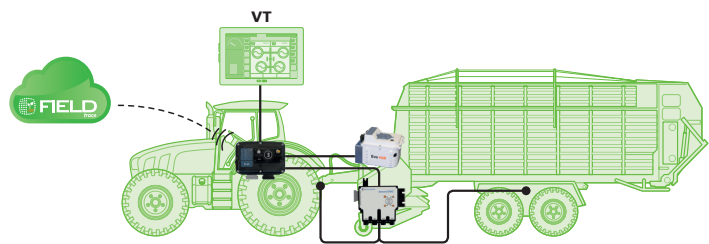

Technological solutions for forage wagons

NIR analysis

Solution

Configuration

Where applicable

Value for customer

EvoNIR
+ Kali Connection Hub
+ Virtual Terminal
+ Field trace



Installation on forage wagons with Virtual Terminal

- Real time ingredient analysis
- Standard ISOBUS connection
- High speed data exchange
- Real time nutrient concentration mapping on Virtual Terminals (with Task Controller)
- Reports available in the Field trace software

EvoNIR
+ Kali Connection Hub
+ Field track app
+ Field trace



Installation on forage wagons w/o Virtual Terminal

- Real time ingredient analysis
- Real time nutrient concentration mapping on Field track app
- Reports available in the Field track mobile app

EvoNIR
+ Kali Connection Hub
+ Field track app
+ Virtual Terminal
+ Field trace



Installation on forage wagons with Virtual Terminal (w/o task controller)

- Real time ingredient analysis
- Real time nutrient concentration mapping on Field track app
- Reports available in the Field track mobile app and on Field trace software



The mineral cycle makes measuring and weighing of harvest fundamental.

Forage wagon can be equipped with NIR sensor only, weighing systems or both NIR sensors and weighing systems. Even though the NIR sensor in combination with weighing systems on forage wagons make the real difference, for each aftermarket installation customer can choose from a wide array of system configuration: from the basic system up to the most integrated solution with weighing, analysis and real time mapping. System measures the exact amount per cargo and per lot. On site collected data can be read right in the field with the terminal in the cab of the tractor.

Weighing solution			
Solution	Configuration	Where applicable	Value for customer
Load Cells + SensorLogic + DG400 ECU		Basic installation on each and every forage wagons	<ul style="list-style-type: none"> Total weight loaded into the forage wagon
Load Cells + SensorLogic + Virtual terminal		Installation on each and every forage wagons with ISOBUS connection and virtual terminal	<ul style="list-style-type: none"> Total weight loaded into the Forage wagon and direct visualization on Virtual terminal Standard ISOBUS connection
Load Cells + SensorLogic + DG400 ECU + Virtual terminal		Installation on each and every forage wagons with ISOBUS connection and virtual terminal	<ul style="list-style-type: none"> Total weight loaded into the Forage wagon and direct visualization on Virtual terminal Standard ISOBUS connection Possibility of viewing the load from outside the wagon
Load Cells + SensorLogic + Kali Connection Hub + Field scale app		Installation on forage wagons w/o Virtual terminal to track loads and their position	<ul style="list-style-type: none"> Total weight loaded into each cart Load position tracking Reports available in the Field scale mobile app Every load/unload is tracked to ensure full process traceability

Weighing + NIR analysis

Solution	Configuration	Where applicable	Value for customer
Load Cells + Kali Connection Hub + SensorLogic + EvoNIR + Virtual Terminal		Aftermarket installation on forage wagons with Virtual Terminal w/ or w/o Task controller	<ul style="list-style-type: none"> • Real time ingredient analysis • Standard ISOBUS connection • Real time nutrient concentration mapping on Virtual Terminal (with Task Controller) • Real time total weight loaded into the wagon
EvoNIR + Kali Connection Hub + Field track app + Virtual Terminal + Field trace		Aftermarket installation on forage wagons to track loads, nutrient values and their position	<ul style="list-style-type: none"> • Real time ingredient analysis • Real time nutrient concentration mapping in the Field track App • Real time total weight loaded into the wagon • Reports available in the Field track mobile app

MAIN ADVANTAGES FOR GROWERS AND CONTRACTORS

MEASURE AND READ OUT IN THE FIELD

- The NIR-sensor measures the dry matter and nutrient concentration; in combination with weight measuring the exact amount per cargo and per lot can be determined. The NIR-sensor is positioned directly above the rotor of the forage wagon where the flow rate is higher and always constant. When the sensor is on, you can measure the loaded crop right away and the instant results can be read on the terminal in the tractor.

FERTILIZING PRECISELY

- With the help of Field track & Field trace software the information gathered in the field is displayed on a quality map directly in the cabin and all data stored in cloud. With this data, you can get insight per lot and even within each lot. The complete map with lots of details at a later stage, gives growers and contractors useful insights for a precise fertilizing.

LOAD CELLS FOR EACH MECHANICAL APPLICATION

- To convert the dry matter and nutrients measured by the NIR-sensor into kilograms of dry matter to determine the gross yield, the forage wagon can be equipped with load cells. Besides the well-known concept with mobile load cells, we are applying also flat load cells between the chassis and the tandem and in case of wagons with hydraulic suspensions the loading pins are placed in the cylinder fixing points. For all forage wagons, a specific load cell is installed in the drawbar-eye.

5.

PRECISION AGRICULTURE SOLUTIONS

5.4 _ Baler

Analyzing bale moisture and nutrients nowadays it is mandatory. The EvoNIR sensor applied on balers determines the exact moisture and nutrients concentration of each bale. Real time bale composition is displayed on Virtual terminals, which prevents unready crop from being baled, and enables the precise application of additives.



On-the-go bale analysis and weighing system

Hay bales analysis is done to improve animal nutrition and production. On most farms, hay is a crucial component of the feeding program. Large bales are analyzed from their core while they are made, layer after layer. Bale weighing sensors are integrated into the bale discharge chute of the baler and register the weight of the bale at the point at which it becomes free from the chute, just before it drops to the ground. All information, including single bale weight, average weight, total weight are all recorded and displayed on the virtual terminal.

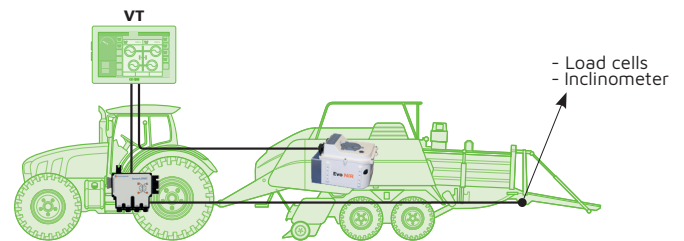

Technological solutions for balers

Solution	Configuration	Where applicable	Value for customer
Weighing + NIR analysis			
Load Cells + Kali Connection Hub + SensorLogic + EvoNIR + Virtual Terminal		Installation on balers with Virtual terminal to track bales weight and their position	<ul style="list-style-type: none"> • Standard ISOBUS connection • Real time bale weighing on Virtual Terminal
Weighing solution			
Load Cells + SensorLogic + Virtual Terminal		Installation on balers with Virtual terminal to track bales nutrient values and their position	<ul style="list-style-type: none"> • Standard ISOBUS connection • Real time bale weighing on Virtual Terminal
NIR analysis			
EvoNIR + Kali Connection Hub + Virtual Terminal		Installation on balers with Virtual terminal to track bales nutrient values and their position	<ul style="list-style-type: none"> • Real time ingredient analysis • Real time nutrient concentration mapping on Virtual Terminal (with Task Controller)

MAIN ADVANTAGES FOR GROWERS AND CONTRACTORS

- Know relevant information regarding each and every bale (nutrients, weight, location etc.) add value to your bales and achieve a premium price
- Measuring the feed value of bales lets you make optimum feed ration and maximize profits
- Continuous analysis nutritional value and weight turn into full traceability, food safety and animal health
- Know your forage = Feed better and increase production
 Breeders can feed their herd precisely, gaining efficiency by saving resources and ensuring expected profit

5.

PRECISION AGRICULTURE SOLUTIONS



5.5 _ Grain cart

Grain carts weighing solution provided by Dinamica Generale is a comprehensive system that provides significant operating gains for growers and contractors. Thanks to its ISOBUS connection with all virtual terminals in the market, no load is missed!

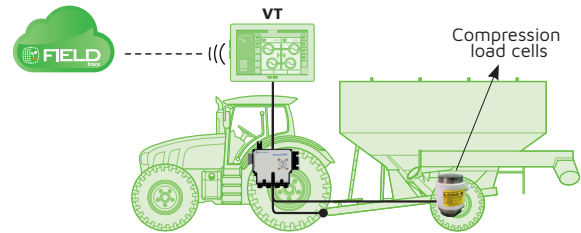

Technological solutions for grain carts

Weighing solution

Solution	Configuration	Where applicable	Value for customer
Load Cells + SensorLogic + DG400 ECU		Basic installation on each and every grain cart	<ul style="list-style-type: none"> Total weight loaded into the grain cart
Load Cells + SensorLogic + Virtual terminal		Installation on each and every grain cart with ISOBUS connection and Virtual terminal	<ul style="list-style-type: none"> Total weight loaded into the grain cart and direct visualization on Virtual terminal Standard ISOBUS connection
Load Cells + SensorLogic + DG400 ECU + Virtual terminal		Installation on each and every grain cart with ISOBUS connection and Virtual terminal	<ul style="list-style-type: none"> Total weight loaded into the grain cart and direct visualization on Virtual terminal Standard ISOBUS connection Possibility of viewing the load from outside the grain cart
Load Cells + SensorLogic + Kali Connection Hub + Field scale app + Virtual terminal		Installation on grain carts w/o Virtual terminal to track loads and their position	<ul style="list-style-type: none"> Total weight loaded into each cart Load position tracking Reports available in the Field Scale mobile app Every load/unload is tracked to ensure full process traceability

MAIN ADVANTAGES FOR GROWERS AND CONTRACTORS

- Know the exact weight of grain going into on-farm storage
- Measure crop yields
- Compare individual fields end seed hybrids
- Save time by weighing directly in field



5.

PRECISION AGRICULTURE SOLUTIONS

5.6 _ Slurry tanker

Precise application of slurry according to pre-determined crop nutrient requirements and regulations is now possible using EvoNIR Near Infrared analyzer.

The same EvoNIR system applied to harvesting equipment for crop analysis can be mounted on slurry tankers for measuring N,P,K.

Precision slurry application with EvoNIR technology

Many farmers spread animal slurry on their crops; what is the main advantage of using the EvoNIR technology on slurry tankers?

- Analyzing slurry with EvoNIR makes spreading more accurate and economic
- Measuring N,P,K content in slurry prior to spreading is advantageous to control nitrates and work within the legal limitations and prevent pollution
- Knowing the nutrient values of what you are spreading ensures full process traceability
- The EvoNIR analyzer is applicable to virtually all slurry tankers and reel hose on the market
- Detailed reports allow for complete traceability by farm, by field, by customer

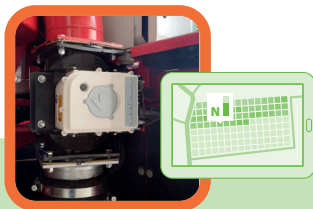

Real-time visualization of total nitrogen quantity distributed thanks to the integration between flowmeter and Kali Connection Hub

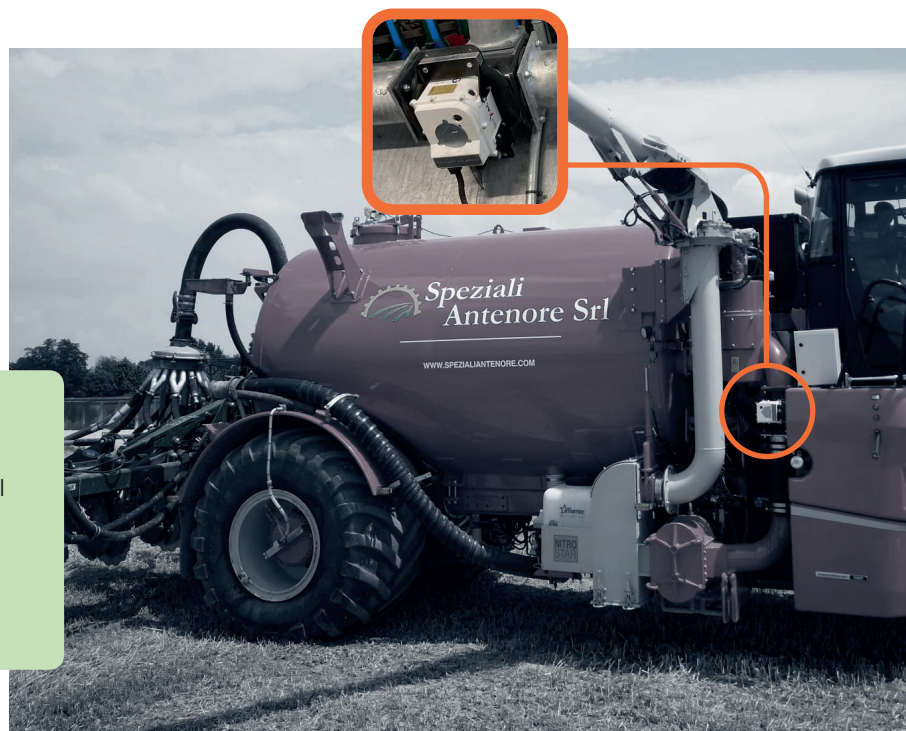

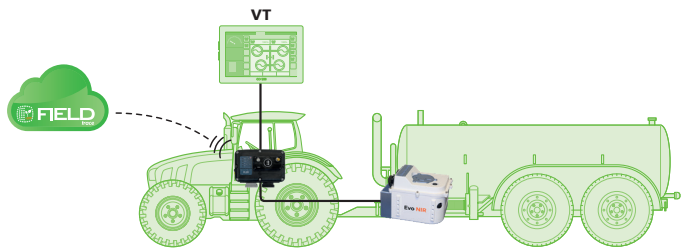

Technological solutions for slurry tankers

NIR analysis

Solution	Configuration	Where applicable	Value for customer
EvoNIR + Kali Connection Hub + Virtual Terminal + Field trace + flowmeter integration		Installation on slurry tankers with Virtual Terminal	<ul style="list-style-type: none"> • Real time ingredient analysis • Standard ISOBUS/CANJ1939 connection • High speed data exchange • Real time nutrient concentration mapping on Virtual Terminals (with Task Controller) • Reports available in the Field trace software
EvoNIR + Kali Connection Hub + Field track app + Field trace		Installation on slurry tankers w/o Virtual Terminal	<ul style="list-style-type: none"> • Real time ingredient analysis • Real time nutrient concentration mapping on Field track app • Reports available in the Field track mobile app
EvoNIR + Kali Connection Hub + Field track app + Virtual Terminal + flowmeter integration		Installation on slurry tankers w/o Virtual Terminal	<ul style="list-style-type: none"> • Real time ingredient analysis • Real time nutrient concentration mapping on Field track app • Reports available in the Field track mobile app and on Field trace software
EvoNIR + Kali Connection Hub + Field track app + Virtual Terminal + Field trace + flowmeter integration		Installation on slurry tankers with Virtual Terminal (w/o task controller)	<ul style="list-style-type: none"> • Real time ingredient analysis • Standard ISOBUS connection • Real time nutrient concentration mapping on Field track app • Reports available in the Field track mobile app and on Field trace software

EvoNIR is DLG certified

The system enables farmers applying N precisely based on nutrient target and/or maximum rate in kg/h. The latest DLG test results have confirmed that the sensor works with comparable accuracy to certified laboratories using wet chemical methods.

The system's continuous analysis, with a complete reading every 20 milliseconds is providing reliable statistical data right in field. Farmers and contractors can now access to real-time quality map in the cab of their slurry tankers thanks to the Field Track Application provided by Dinamica Generale.

CUSTOMERS' BENEFITS

- More precise application of plant nutrients in forage maize, grass, wheat
- Easier and more precise slurry documentation for local regulations compliance
- Immediate information available
- Cost savings on: mineral fertilisers and sampling costs
- Increasing profitability and cash flow: sell kg of Nitrogen instead of tons of slurry
- Environmental protection & traceability



5.

PRECISION AGRICULTURE SOLUTIONS

5.7 _ Manure & Mineral spreader

The GeoSpreader System is designed to control the distribution of manure and solid fertilizers.

The system ensures effective material spreading in accordance with following parameters:

- Planned spread factor
- Homogeneity of material distributed in relation with ground speed of the machine.

The system can be installed on manure spreader machines, trailed or pulled-up fertilizer spreaders and lets you control the speed of any belt or chain system.

Saving spreads everywhere

Added efficiency mean savings! Farmers can run the weighing system choosing between manual or auto mode and set forward speed, speed of belt or chain, spread width and target spread rate in t/ha or t/ac for the maximum efficiency in use.

- **Manual mode:** manual adjustment of the spreading factor.
- **Auto mode:** the machine will slow down and speed up the internal belt to maintain the same application rate

If the manure spreader is equipped with load cells, the GeoSpreader system will calibrate itself in real-time.

The indicator will also display a record of how many kg/pound has been distributed to adjust rate accordingly.

The system will also work with GPS for improving loadout efficiency.



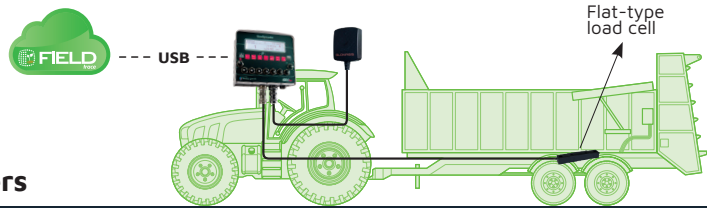

Technological solutions for manure spreaders

Weighing solution

Solution	Configuration	Where applicable	Value for customer
Load Cells + SensorLogic + DG400 ECU	<p>LOAD CELLS</p>	Basic installation on each and every manure spreader or mineral fertilizer with different weighing sensors installed	<ul style="list-style-type: none"> • Weighing of loaded manure • Real-time visualization of remaining load
Load Cells + GeoSpreader Basic/Superior + Field trace	<p>LOAD CELLS</p>	Installation on each and every manure spreader or mineral fertilizer	<ul style="list-style-type: none"> • GeoSpreader Basic. Real-time visualization of manure distribution (kg/ha or t/ha). • GeoSpreader Superior. Automatic manure distribution to keep constant spreading ratio (kg/ha or t/ha) • Mapping the quantity of manure distributed through Field trace software



GeoSpreader SUPERIOR version

The SUPERIOR version is capable of regulating machine functions like opening of slide gate vales to ensure effective material spreading in accordance with:

- Planned spreadfactor
- Homogeneity of material distributed in relation with ground speed of the machine

BENEFITS FOR OEMS AND FARMERS/ CONTRACTORS ALIKE

- Keep manure/fertilizer distribution homogeneous in accordance with planned spread factor
- Fulfil local manure spreading regulations
- Homogeneous distribution turns into:
 - higher yields and land productivity
 - increase profits
 - quick and high distribution efficiency
- Excellent price-performance ratio

5.

PRECISION AGRICULTURE SOLUTIONS

5.8 _ Traceability of grain process

Blockchain technology is going to transform the agribusiness sector. Data is shared by multiple entities operating on the same network that verify traceability of crops end-to-end.

No missed loads!

Every load is tracked to ensure full control of the process: from combine, grain cart, up to grain truck and grain elevator.

Every step of the process is controlled. The total weight loaded is managed.

Solution	System configuration	Where applicable	Value for customer
Combine harvester			
EvoNIR + Kali Connection Hub + Field track app + Field trace		Installation on combine harvesters w/o Virtual Terminal	<ul style="list-style-type: none"> • Real time ingredient analysis • Real time nutrient concentration mapping on Field track app • Reports available in the Field track mobile app
Grain cart			
Load Cells + SensorLogic + Kali Connection Hub + Field track app		Installation on grain carts to track loads and their position	<ul style="list-style-type: none"> • Total weight loaded into each cart • Load position tracking • Reports available in the Field track mobile app
Grain truck			
Field track app		Aftermarket solution. No installations required. Track loads and their position	<ul style="list-style-type: none"> • Truck ID management • Weight of grain in the truck



- Granular map based on data recorded from the NIR analyser on combine
- Full traceability of grain processing: combine – grain cart – truck- elevator
- Record and manage grain loads based on their weight and quality
- Record and manage truck routes from field to grain elevator

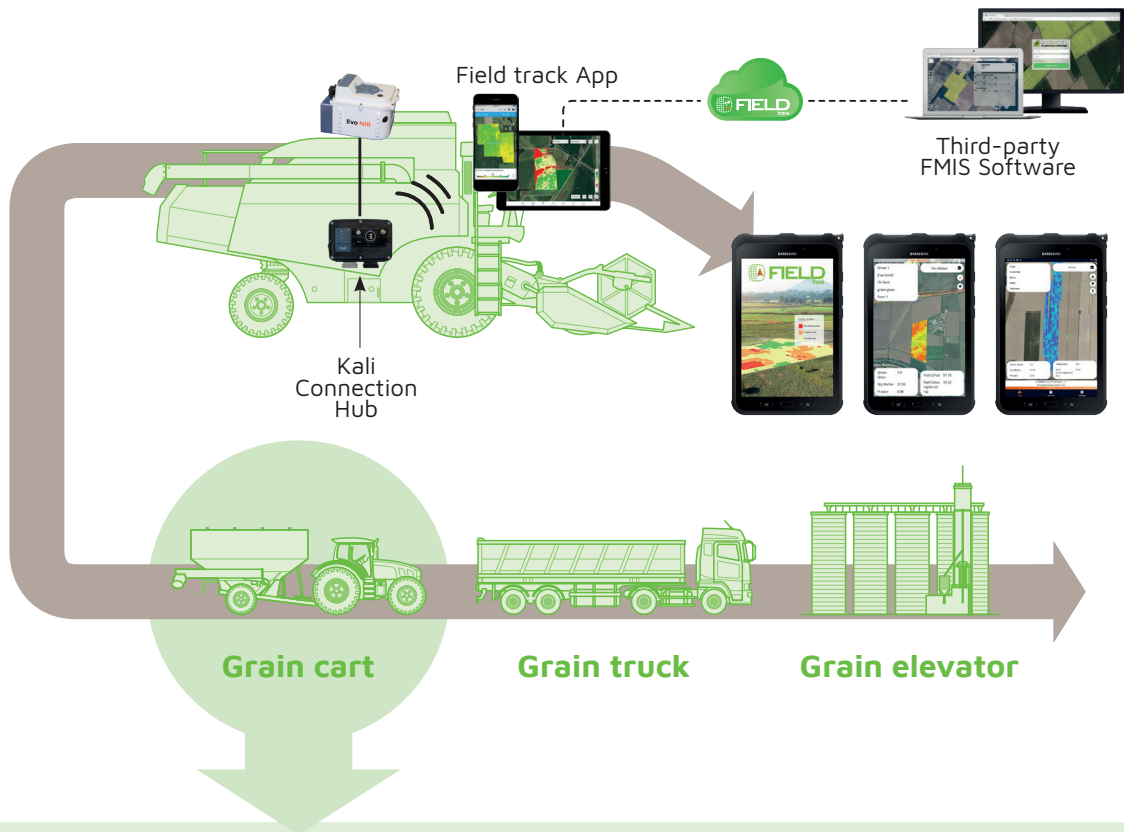

- Automatic Unload Detection**
 Field scale app automatically detects and records how much grain has been loaded to the grain cart or unloaded from the grain cart.
- Manage Data**
 Possible to edit customers, fields, farms, crops, operators, machines etc.. The customer just pick what he needs to track the process.
- Data Sharing with Field trace**
 Harvest data are automatically synced with Field trace cloud software.

BENEFITS FOR SMALL FARM OWNER OR CONTRACTOR

- Properly managing grain segregation and blend in the field thanks to nutrients analysis with EvoNIR on combine harvester
 - **Dry Matter (DM)** – if average DM content is beyond 14% grain needs to be dried
 - **Protein** – measuring protein level let farmers segregate grain for bread, pasta or animal feeding, etc
 - **Gluten** – content of gluten influences the baking properties of flour. The gluten content let farmers segregate grain for bakery usage
- Take back control over the sale of grain to optimize income
- In-season crop constituent data mapping let farmers to accurately fertilize the next season



BENEFITS FOR LARGE FARMS AND CONTRACTORS

- All benefits listed above, with also:
- Control grain from the combine into grain cart, trucks, silos.
 - Logistics traceability
 - Knowledge of mean values for valuable grain constituents
 - Evaluation of total harvesting income/expenses



BENEFITS FOR GRAIN HOLDING COMPANIES

- All benefits listed above, with also:
- Increasing grain elevator productivity while speeding up price making decision
 - Track mean value of grain constituents in every silo
 - General profitability estimation at every stage of grain processing



5.9 _ Optimize farming processes using real-time data

UNLEASH THE POWER OF DATA
WITH EVONIR AND FIELD TRACK

With Field Track Mobile APP, farmers visualize real-time crop map, collect sensors data and analyze the information gathered in the field with Field trace cloud software to evaluate current practices and make improvements for greater efficiency and effectiveness.

Control quality map in real-time from your mobile



View data from your smartphone, print or share maps and reports through e-mail, Whatsapp, Google Drive, etc.



Data are seamlessly uploaded into your Field trace account. Open Field trace to print statistics, compare crops year after year, review performance thanks to many reports available.



All systems
are ISOBUS
compatible !



GET THE MOST OUT OF YOUR CROPS

- Create your field right in the Field Track app and see real-time quality mapping from your mobile.
- Wireless solution, free you from the headaches of wires in the cab
- Manage executions and quality map from your smartphone, print or share reports through e-mail, Whatsapp, Google Drive to name but a few...
- Fast and secure data transfer with 4G high-speed modem
- Field trace 2020: new edition! Easy to use and automatically integrated with other software through API





5. PRECISION AGRICULTURE SOLUTIONS

5.10 _ Precision farming mobile applications

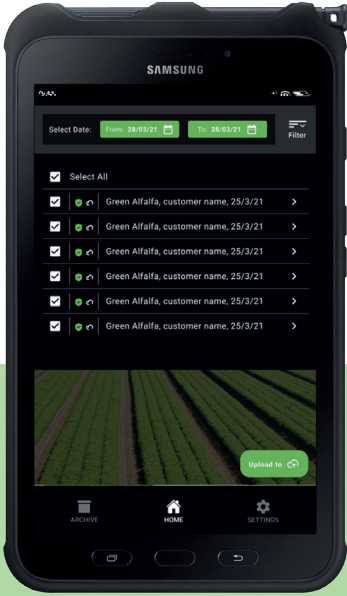
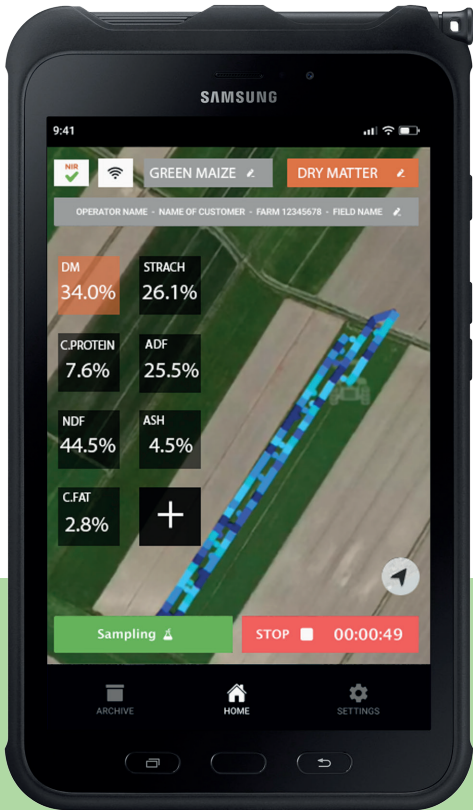

Field track is a tablet and smartphone-based app for in-cab real-time crop quality mapping. Available for combine, forage harvester and slurry tanker application, the Field track app is mounted in the cabin of your machine and wirelessly communicates with the Field trace Cloud software.

FieldTrack mobile app allows farmers and contractors to analyze information collected in the field to evaluate current practices and improve efficiency for future treatments.

Google Play

Currently compatible with Android devices running versions 9.0 or newer

- Collects and shares data from connected sensors to the Field trace cloud software
- Operators can control quality crop maps collected in the field to evaluate current practices and improve efficiency for future treatments.
- Maps and reports can be easily shared through e-mail, Whatsapp, Google Drive, etc.

» Agricultural professionals now can increase their profitability and productivity by using mobile technology developments.

Mobile applications provided by Dinamica Generale are Field track and Field scale. The first one is designed for visualize real-time maps based on NIR analysis of crops; while the second tracks grain weighing, loading and unloading from field to storage.



Field Scale is a tablet and smartphone-based app that records and tracks weighing of harvested grain and forage. Available for grain carts and forage trailers application, the Field Scale app is installed in the cabin of the tractor and wirelessly communicates with the Field trace Cloud software.

Field Scale app automatically records weight, GPS location, date and time of each load and provides load tracking from field to truck to destination.

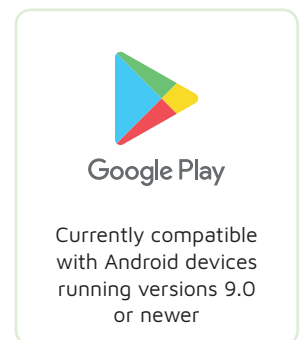
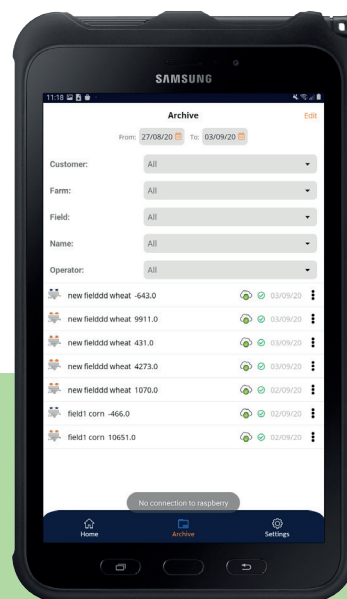
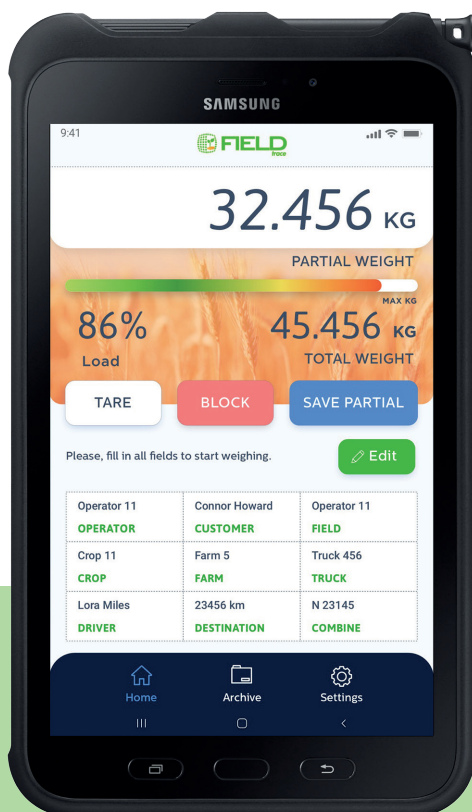

Field Scale allows farmers and contractors to monitor the complete grain harvest process:

- Recording how much grain has unloaded from combines into grain carts, trucks, grain elevators
- Tracking how much forage has unloaded from forage harvesters into trailers, trucks, farms...
- Production traceability
- Evaluating total harvesting income/expenses

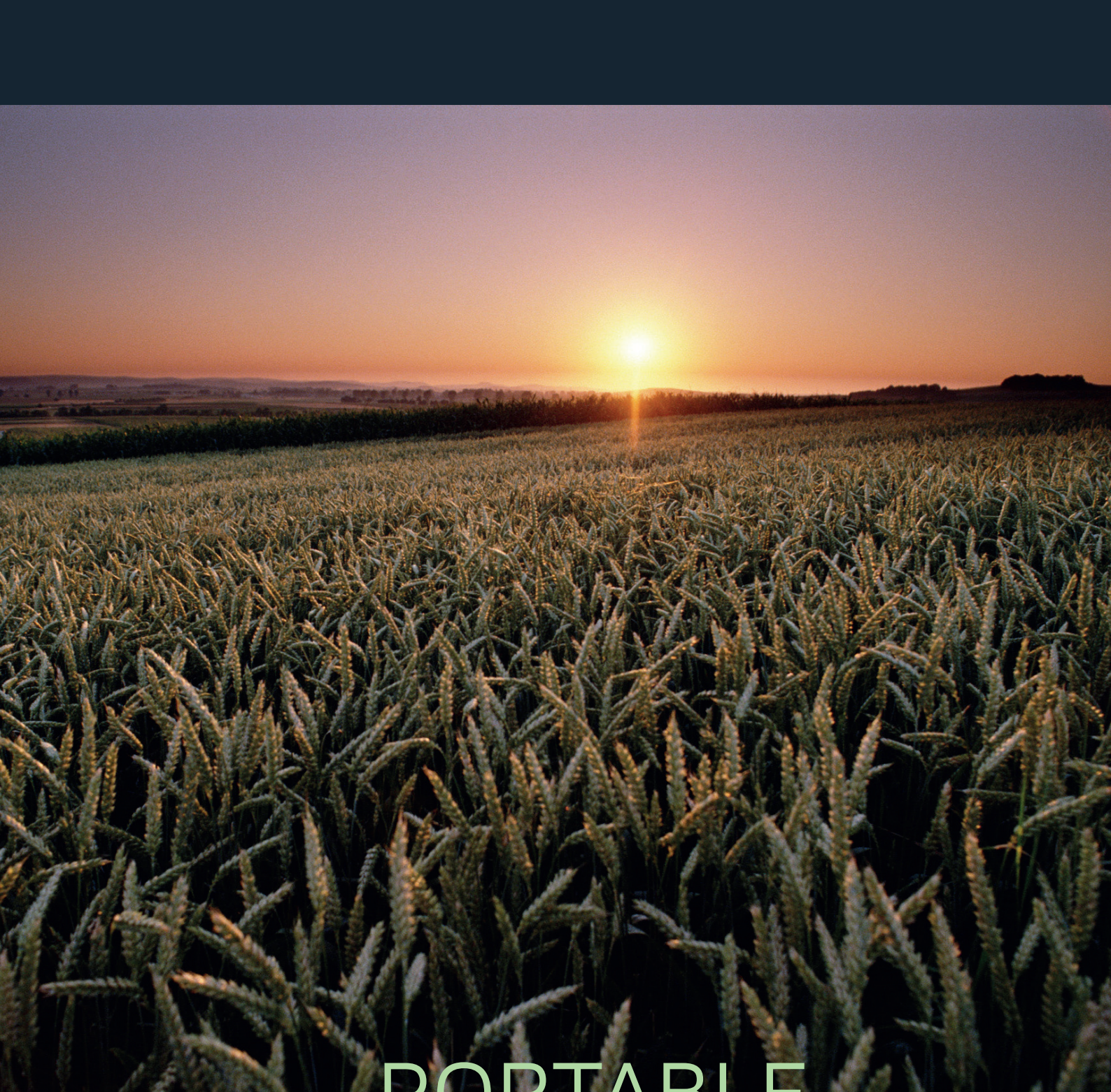

PORTABLE
ANALYZERS

»
**WHY CONSIDER
DINAMICA
GENERALE NIR
ANALYZERS?**

Dinamica Generale offers a complete near infrared spectroscopy range that includes technology and services:



on board and portable analyzers



calibration transfer software



calibration development



installation services



Extensive database of calibrations



on-site service and on-going remote support



6.1 _ AgriNIR portable analyzer for forage, hay, silage, grain and slurry



AgriNIR

Your own lab on-the-go

Dinamica Generale introduced the AgriNIR back in 2008. AgriNIR is a tried and tested portable NIR analyzer for grass, forage and grain that analyzes the percentage of moisture (dry matter), crude protein, starch, ADF, NDF, ash in seconds.

AgriNIR is also available for pig and cattle slurry analysis. This version is capable of analyzing the percentage of nitrogen (N), phosphorus pentoxide (P2O5), potassium oxide (K2O).

- **AgriNIR: 7 preloaded ingredients as standard (Corn Silage, Hay, High Moisture Corn, Alfalfa Hay, Grass Silage, TMR, Soybean Flour)**
- **AgriNIR Slurry: 3 preloaded ingredients as standard (digestate, pig and cattle slurry)**
- **Connects to computer via USB port and wi-fi with GoCloud Gateway to share results and perform statistics**
- **Print out reports right after the analysis thanks to the built-in printer.**

Main target customers



Precision Feeding

Nutritionist

AgriNIR is the nutritionist's toolbox for feed sampling, testing and ration adjustment in real time. Dairy farmers need quick and accurate recommendations. The more time it takes for a response, the more impact it can have on milk production and the bottom line.



Precision agriculture

Grower/Contractor

AgriNIR: determining the right time to harvest is extremely important and sometimes difficult. Thanks to AgriNIR the right timing of cutting can be easily determined analyzing dry matter contents of samples from windrows or different crops on-the-go

AgriNIR Slurry: speeding up the process of slurry analysis in the field before fertilizing cuts costs, time and increase productivity.



Biogas plants

Plant owner

Biogas plant managers can perform a full NIR analysis to check the DM and all other parameters of loads of grass and silage delivered by contractors. The analysis can be done in the silage pit too and in under any circumstances since the analyzer can be powered by the tractors/car's lighter.

AgriNIR CUSTOMERS' BENEFITS

- **Reliable.** The highest possible accuracy on-site.
- **Robust.** Sturdy case, full-portability, minimum maintenance
- **Versatile.** Determine the right time to harvest. Check quality of feed purchased. Control feed inventory.
- **Profitable.** Value for money
- **Quick and easy to use.** NIR analysis in seconds!

6.2 _ X-NIR handheld analyzer for forage, silage and grain

**X-NIR****Daily handheld analysis for everyone**

X-NIR Portable NIR Analyzer for Anywhere, Anytime grains and forages analysis. By taking NIR technology in field in the form of a portable, handheld NIR analyzer unit, such as the X-NIR, growers and contractors can obtain real-time results while reducing costs from third-party testing.

X-NIR takes lab-proven technology off the bench and makes it usable by non-scientists. Results that are available within minutes on-site enabling actionable decisions that increase profitability.

- 3 ingredients as standard on each analyzer to pick from more than 60 ingredients available
- Connects to computer via USB port and wi-fi with GoCloud Gateway to share results and perform statistics
- 4"3 Touch screen lets you access all functions with a simple fingertip

Main target customers**Plant owner**

Measuring acceptance of raw materials before processing reduces down-time and production delays.

**Dairy farmers**

For small to medium-sized dairy farms as portable solution for real-time daily feed analysis. Feed livestock the most effective ration as prescribed from the nutritionist.





X-NIR CUSTOMERS' BENEFITS

- **QUICK:** Never wait to get results again. X-NIR delivers full NIR analysis in less than a minute
- **SIMPLE:** Analysis are performed without sample preparation, no cutting, milling or drying
- **RELIABLE:** Analyse all types of materials from forages to grass up to grains
- **COST EFFECTIVE:** no cartridge, consumables or other expensive accessories every time you analyze
- **ECONOMICAL:** X-NIR directly impacts the profitability of the user organization allowing a tremendous increase in number of analysis performed on site without increasing the cost per analysis.
- **EASY TO USE:** the X-NIR does not require any specific technical knowledge and it is user-friendly. The operator chooses what he wants to analyze, the ID of the sample and the number of scans he wants to do for every analysis... and then he presses the trigger!
- **ACCURATE:** With the X-NIR portable NIR analyzer not only the amount of dry matter, but also the amount of protein, crude fat, ash, ADF, NDF and other nutrients are all detected within seconds

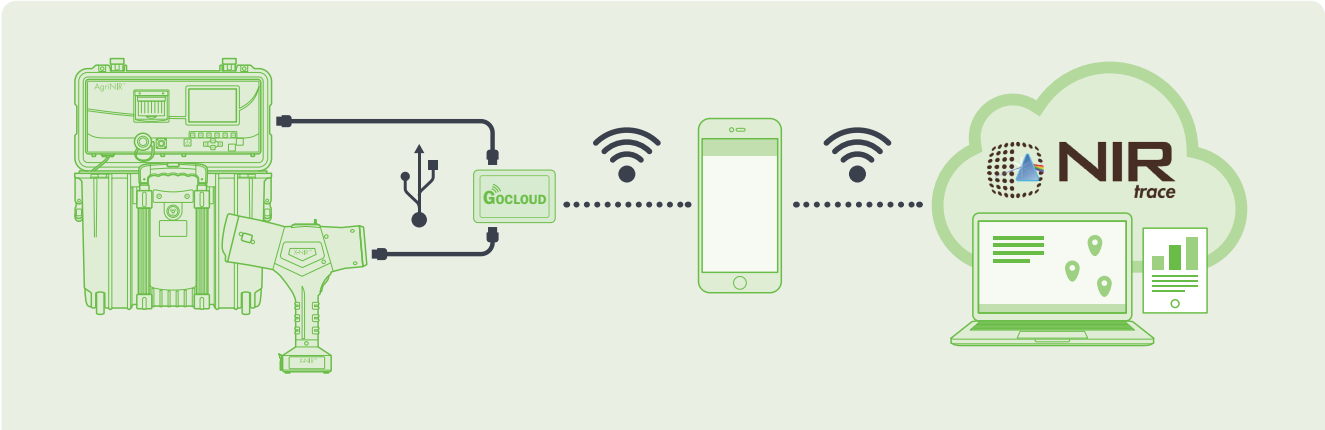

- NIR analysis storage and backup
- View and download advanced reports and trends
- NIR trace software can be used with multiple NIR analyzers

TRUSTWORTHY NIR CALIBRATIONS. GET BETTER RESULTS. SIMPLY.

Ingredients available

Decades of experience and know-how in NIR technology gives worldwide users the opportunity to choose GLOBAL Calibrations, usable everywhere and a comprehensive database of LOCAL country-specific calibrations that enable to customize even further each NIR analyzer developed by Dinamica Generale.



12 Global Calibrations



48 Local Calibrations



Global Lab network

Global Calibrations

Corn Silage	Dry Alfalfa Hay	Soybean Flour	Green Grass
Dry Grass Hay	Grass Silage	Alfalfa Haylage	Cow Slurry
High Moisture Corn	Dairy Cows TMR	Green Maize	Pig Slurry

Local Calibrations

Corn Grain	Dry Beet Pulp	Dry Corn Stalks	T.M.R. Low Protein
Wheat Grain	Dry Corn Distillers	Green Rye	Dairy Bulls TMR
Olive Husk	Dry Grain Distillers	Oat Hay	Earlage
Soya Oilcake	Bran	Wet Brewers Grain	Dairy Cows TMR
Sunflower Oilcake	Wet Corn Distillers	Corn Germ Flour	Dry Corn Stover
T.M.R. High Protein	Snaplage	Green part of Maize	DDGS - Dried Distillers Grains with Solubles
Sunflower Meal	Green Alfalfa	Whole Wet Grain	Pellet Product
Wet Corn Gluten	Triticale Silage	Barley Silage	Whole High Moisture Corn
Sorghum Silage	Green Triticale	Soybean Grain	Wheat Hay
Rapeseed Meal	Wet Grain Distillers	Wheat Silage	TMR - Dry Cows
Barley Grain	Oatlage	Wheat Green Forage	
Semolina Flour	Treated Corn Stalks	Unifeed PR	



Ask the NIR expert

Need help or advice from an expert? If so we are here to help

We understand that for many of our new customers the NIR technology can be sometimes difficult. Don't worry we have all of the help and advice that you will need, visit our website and get in contact with us.





SMART

CONNECTIVITY

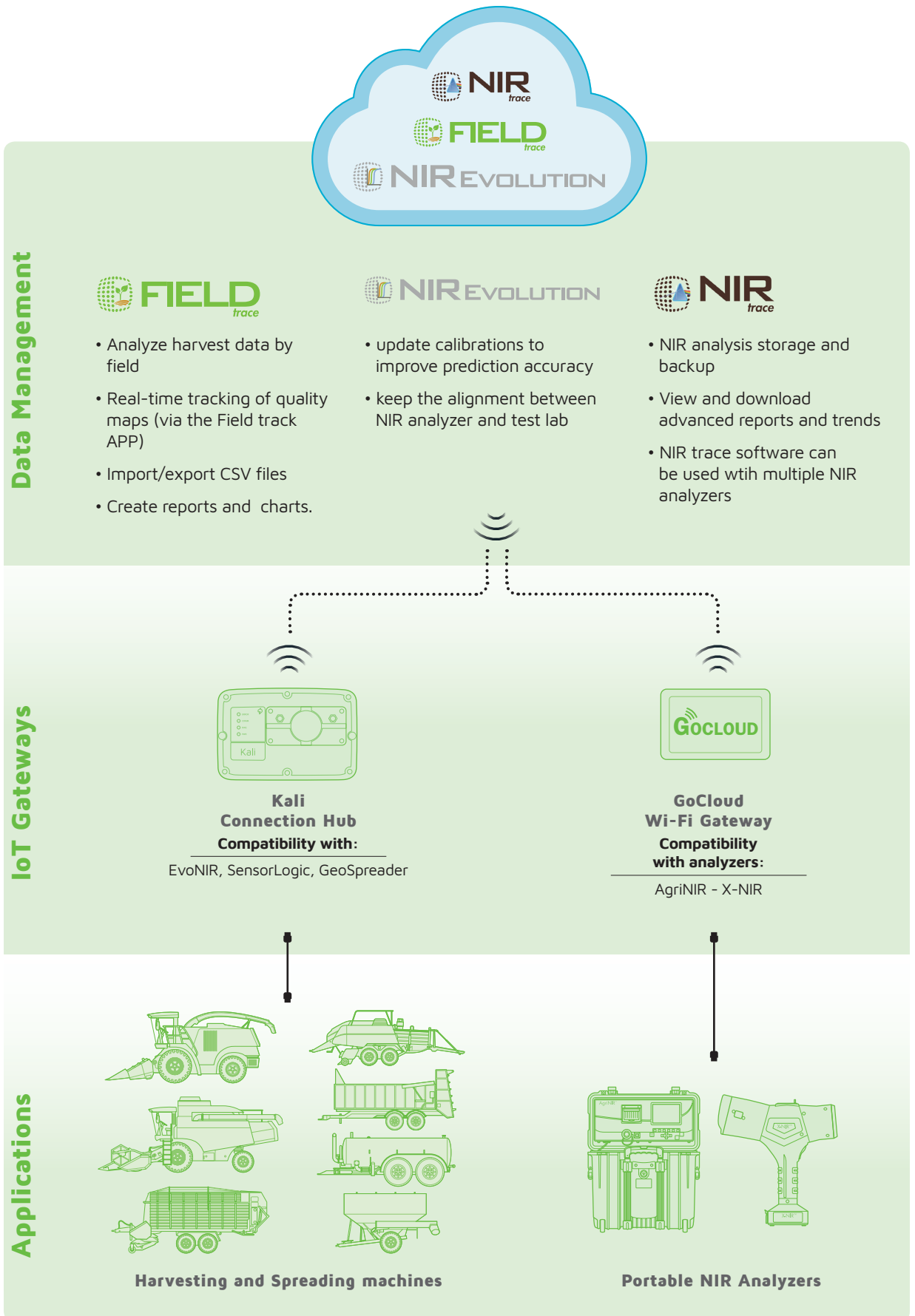

7.

SMART CONNECTIVITY AND DATA MANAGEMENT

7.1 _ IoT Gateway



The Internet of Things (IoT) is helping change the way farmers work. The precision farming concept of Dinamica Generale uses sensors, data, and network communication to enhance agriculture machineries to the progressive farmers' specific needs. The result is an efficient system that promotes sustainable growth while cutting costs.

The core of the precision agriculture platform of Dinamica Generale lays in the Kali Connection Hub.

Kali Connection Hub makes it easy to connect NIR and weighing sensors installed on machines running in field with cloud software through mobile devices, and virtual terminals.

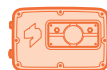

SMART CONNECTIVITY



Full wireless connectivity



Remote software updates



Standard communication protocols



Remote serviceability



The Kali Connection Hub platform is the cornerstone of our precision ag portfolio. Combining our software and firmware capabilities with high-quality hardware we created a unique platform that receives and syncs data with apps and cloud software.



- Remote diagnostics
- Update calibration curves
- Firmware updates



- Wireless data sync

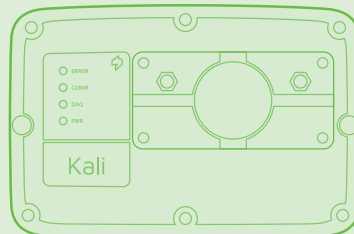

BETTER CONNECT YOUR MACHINE

The ability to connect the Kali Connection Hub to different cloud software to remote monitoring diagnostics, update calibration curves of NIR analyzers and sync data with Field trace software is key for being efficient. Using our technology across daily operations make everything smooth and effective. No longer you have to wonder how idle time impacts your performance, with Dinamica Generale's IoT gateways, you can manage data in real-time automatically.

7.2 _ Field trace

PUT YOUR DATA TO WORK WITH THE NEW FIELD TRACE 2020

Field trace is the cloud software that connects your Dinamica Generale smart devices such as NIR sensors, Kali Connection Hub, Field track and Field Scale app to manage precision farming data and display the most valued information from every field to optimize crop yields and next season treatments.

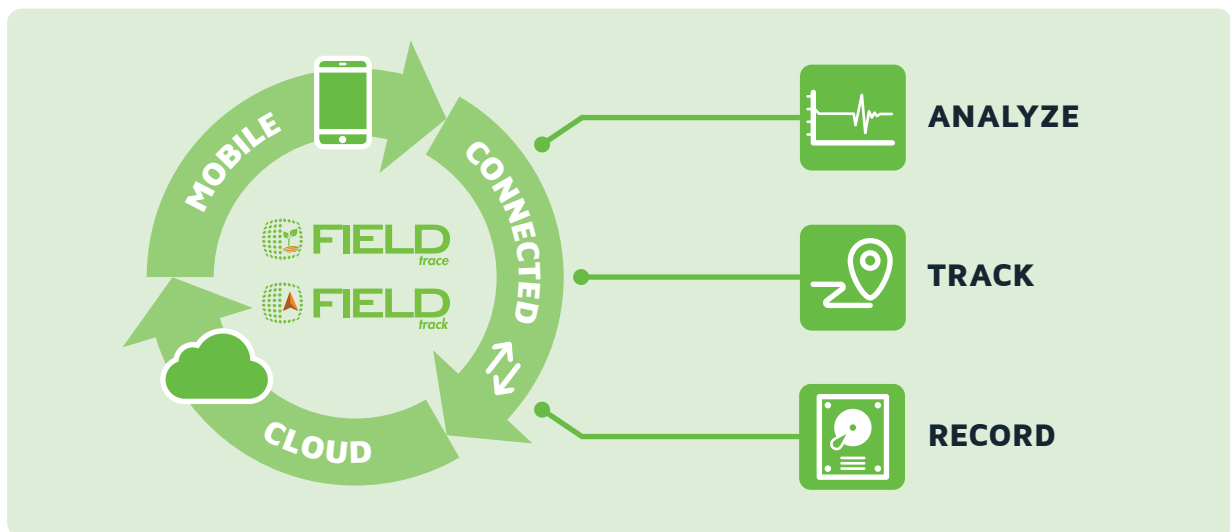

Field trace. User friendly and easy set up like never before

Create customers, farms and fields easily from the Field trace software and exchange programming to the Field track app.

Field track app tracks nutrients in real time while machines are running and get instant maps of your field in the cab. Get the job done and send back execution data to Field trace that helps you managing precision farming data

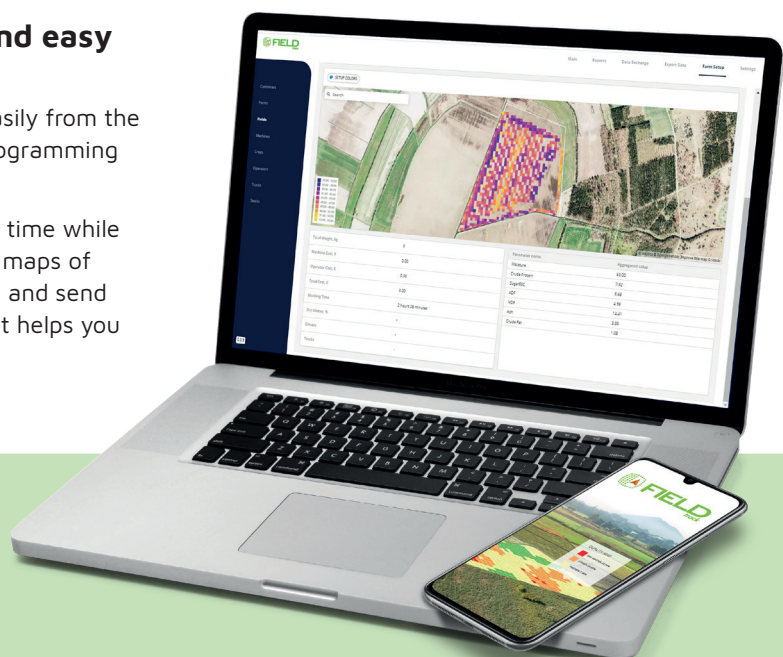

Streamline field operations

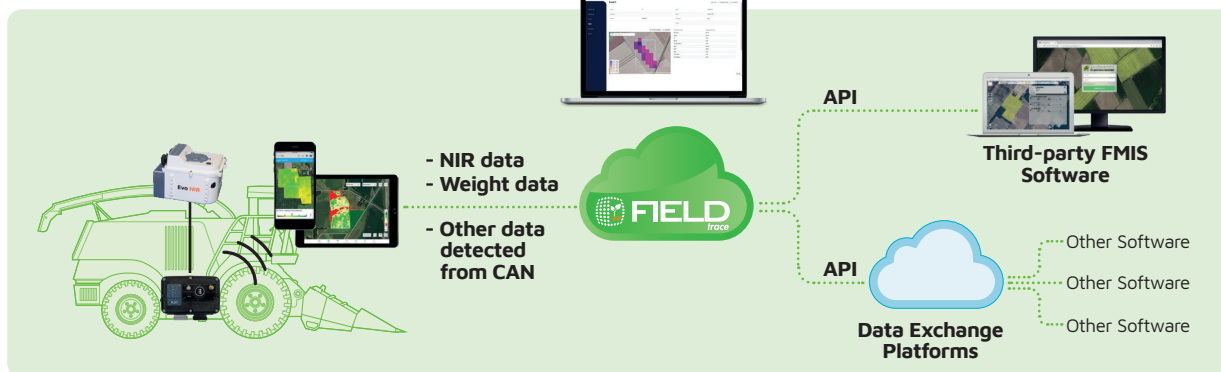

Manage integration between Field trace and third-party digital farming cloud software via API in a seamless and transparent way.

Improve field record reliability

Data collected in the field is a valuable asset to manage customers, track fields, analyze performance, view and compare historical data, generate reports and take actionable decisions for each field.

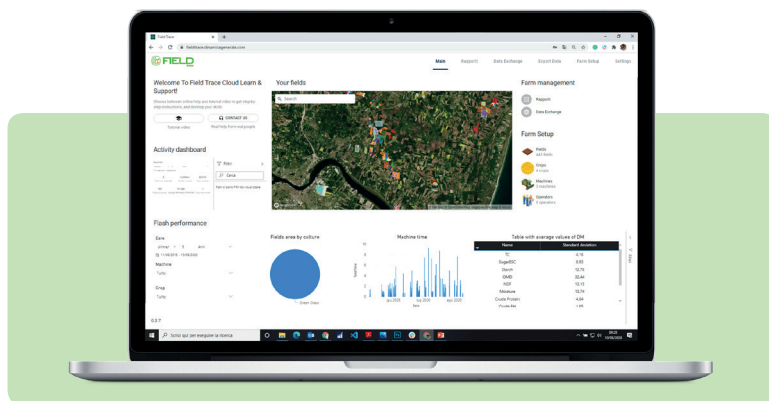

Get your field data in one place

Make field data management simple with Field trace. Collect, store, back-up and view your field data in our easy-to-use digital platform that you can access from anywhere.

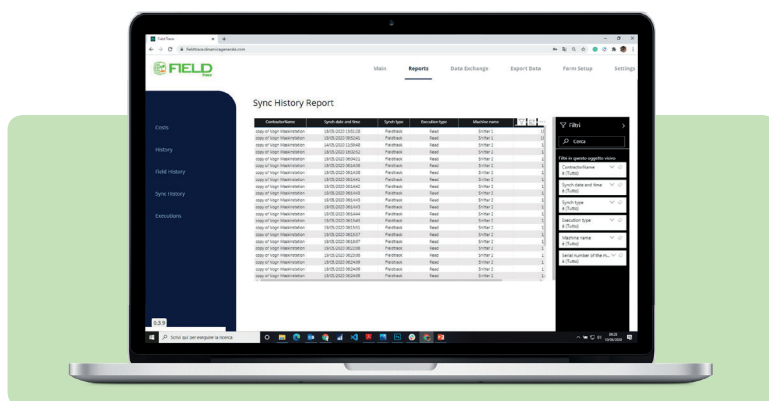

Get the most out of your data

Make data driven decisions to maximize your return. Collect and visualize field data reports to monitor and measure the impact of your agronomic decisions on crop performance.

- **Manage costs:** this report gives you a clear picture of costs that you are sustaining for each machine and each operator
- **Execution history:** this report is a summary of all executions, each report includes the average DM value for each execution
- **Field analysis history:** this report shows details of crop analysis for each execution
- **Sync history:** this report is a summary of all programs send and executions acquired by the Field trace software

7.3 _ NIRevolution

The power of the Internet of Things.

The remote monitoring, diagnostics and calibration updates provided by Dinamica Generale improve your NIR analyzer performance by enabling our service personnel to remotely diagnose and proactively respond to any instrument issues.

When the NIR Evolution cloud software is initiated, the the analyzer's performance data is sent to a secure cloud based system on a periodic basis. This allows our service support team the ability to immediately and proactively troubleshoot, diagnose, and help maintain the highest performance of your NIR instruments.

The Dinamica Generale Service department is responsible for monitoring the instrument's critical operating parameters, allowing you peace of mind that your unit is always functioning according to our specifications.

**Features**

- Ensures EvoNIR analyzer up-time and accuracy
- Enables remote monitoring and diagnostics from almost anywhere in the world
- Decrease total cost of product ownership
- Reports historical performance data

Main benefits:

- Proactive problem detection and automated service initiation
- Decrease time for troubleshooting and diagnosis
- Remotely controlled resolution of problems
- Less time spent on the phone with service personnel
- Version control of calibration curves, software and firmware for the best NIR prediction

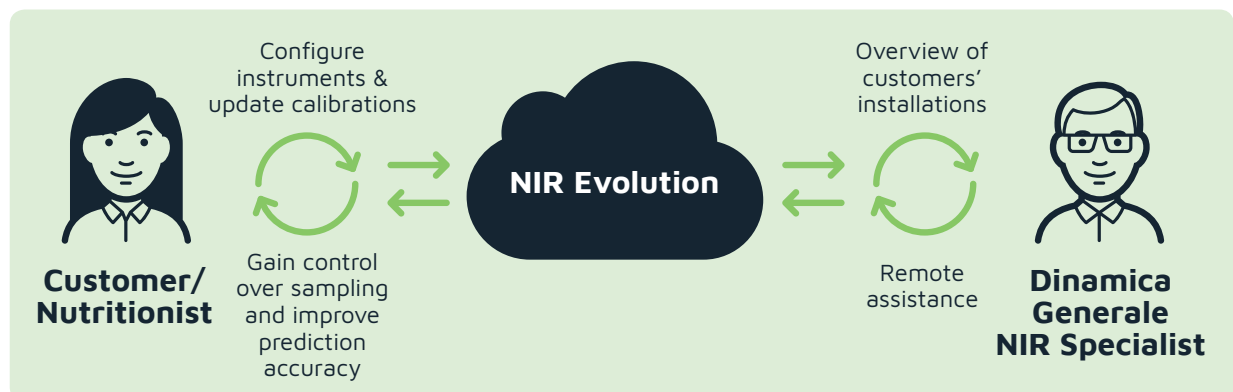

8.1 _ Optical sorting technology for tomato and potato

The tomato and potato optical sorters detect and remove all types of foreign material such as animal matter, metal, cotton stalks, plastic, stones, glass, and wood from field run tomatoes and potatoes.



Key features

- The precise and powerful vision system allows the sorter to work perfectly in every daylight condition
- Wide range of colour regulation (from green to red, from dark land to white stones)
- Possibility to decide whether to eject the plant/leaves
- Remote console at the driving place for the control of the main functions
- Available as "digger" configuration
- Possibility of programming the sorter through PC with direct connection
- Multi-language interface of command strings selected from a parametrical menu
- Interface with 3 graders at the same time
- 3G communication (worldwide covering) for the complete control of grader can be made directly from the office
- In case of defects an automatic call to the assistance centre permits to solve troubles straight away and closing the working day
- Speed and counting of picked hectares can be viewed directly on the display

CUSTOMERS' BENEFITS

- Increased yield
- Reduced labor requirements
- Increased throughput rate
- Consistent and reliable results
- More than 20 years of field experience

BLOCKCHAIN TRACEABILITY

GRAIN HARVEST

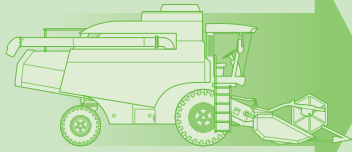

Combine

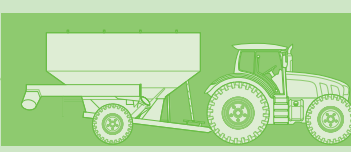

Grain Cart

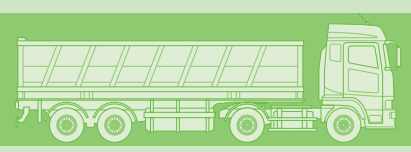

Grain Truck

FORAGE HARVEST

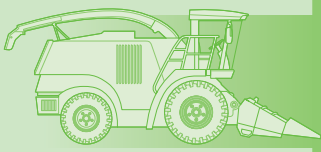

Forage Harvester

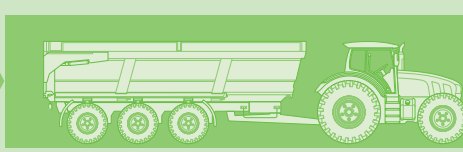

Forage Trailer

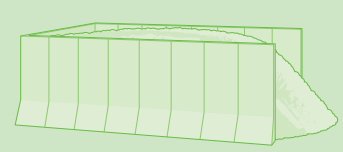

Silage Bunker

GRASS HARVEST

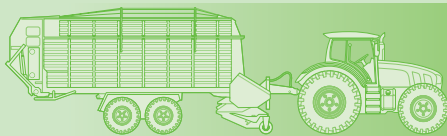

Forage Wagon

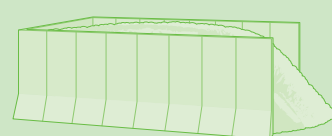

Silage Bunker

HAY/GRASS HARVEST



Baler

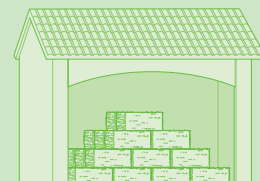

Hay Bale Stockpile

MANURE/SLURRY DISTRIBUTION

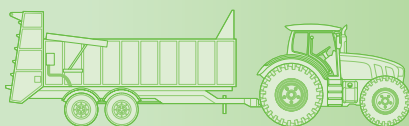

Manure Spreader

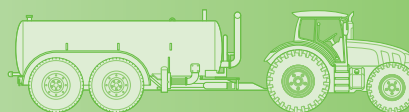

Slurry Tanker

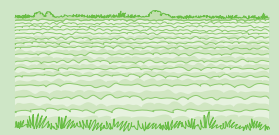

Soil Fertilization

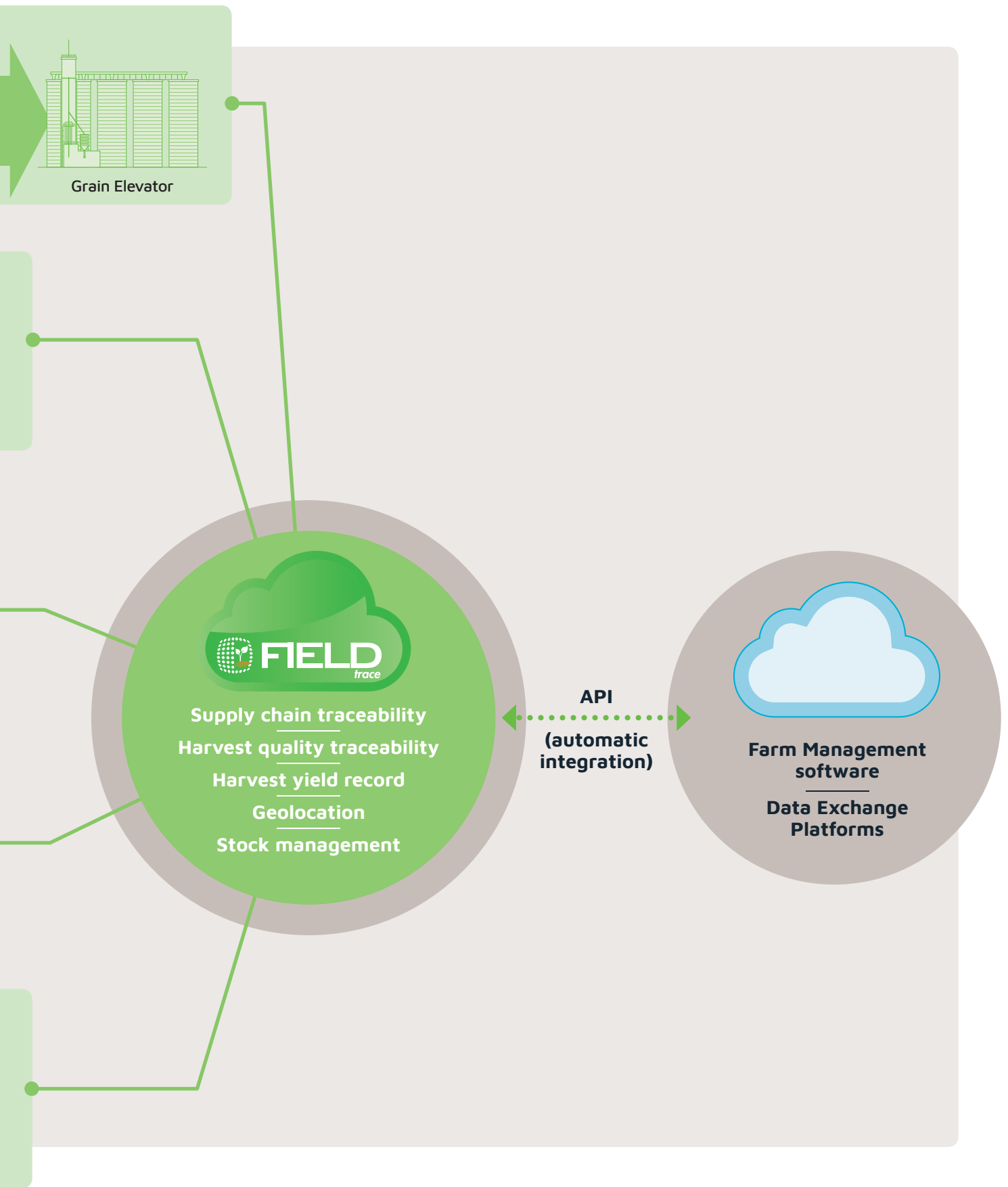

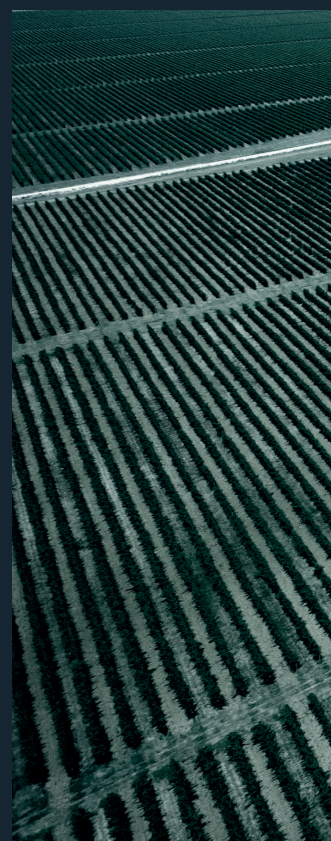

DINAMICA GENERALE S.p.A.
Via Mondadori, 15 - 46025 Poggio Rusco MN - ITALY
dinamicagenerale.com

 [dinamicagenerale](https://www.facebook.com/dinamicagenerale)

 [@dinamicagen](https://twitter.com/dinamicagen)

 [dinamica generale](https://www.youtube.com/dinamica generale)